

Compliments of:

METAL-FAB, INC.

P. O. Box 1138 3025 May Avenue
WICHITA, KANSAS 67201

VENTING TABLES
CATEGORY I CENTRAL FURNACES



COPYRIGHT © 1990
GAS APPLIANCE MANUFACTURERS ASSOCIATION

SPECIAL METAL-FAB UPDATE AS OF MARCH 2000

The venting tables within this booklet have now been included in the National Fuel Gas Code (NFPA 54/ANSI Z223.1-1999). That code may also be used to size venting systems for draft hood equipped central furnaces or for fan-assisted combustion system central furnaces.

GAMA VENTING TABLES FOR CATEGORY I CENTRAL FURNACES

This booklet contains new venting tables designed specifically for use with Category I central furnaces. These tables are unique, in that, industry wide venting tables now exist for fan-assisted combustion system central furnaces. Venting tables for these types of appliances are not contained in the National Fuel Gas Code (NFPA 54/ANSI Z223.1-1988).

All requirements contained in this booklet apply to both Category I draft hood equipped central furnaces as well as fan-assisted combustion system central furnaces. At no time should a venting system for a listed Category II, III, or IV central furnace be sized with these tables. The National Fuel Gas Code (NFPA 54/ANSI Z223.1-1988) may also be used to size venting systems for draft hood equipped central furnaces. However, at this time, the National Fuel Gas Code does not include alternate sizing methods for fan-assisted combustion systems. Therefore, until engineering data is developed to allow alternate sizing methods for Category I fan-assisted central furnaces, the enclosed venting tables must be used for fan-assisted combustion system central furnaces. These tables apply to venting single appliances and common venting multiple appliances in both metal and masonry chimneys.

The new venting tables were developed by Battelle under contract (GRI-5088-245-1728) to the Gas Research Institute (GRI). The computer program (VENT-II) developed by Battelle Columbus generated the venting tables in this booklet and this procedure has been accepted by the American Gas Association Laboratories as an appropriate engineering methodology for determining venting requirements of Category I central furnaces.

For your information, the general venting requirements listed in this booklet are not intended to be used as complete installation instructions and represent only a partial list of venting considerations.

For venting applications that fall outside the parameters of the new venting tables, refer to the furnace manufacturer's complete installation instructions, the specific vent manufacturer's complete installation instructions, and state and local codes.

GRI DISCLAIMER

LEGAL NOTICE: This information is, in part, a result of work performed by Battelle under the sponsorship of the Gas Research Institute (GRI). Neither GRI, members of GRI, nor any person acting on behalf of either:

- a. Makes any warranty or representation, express or implied, with respect to the accuracy, completeness, or usefulness of this information, or that the use of any apparatus, method, or process disclosed may not infringe privately owned rights; or
- b. Assumes any liability with respect to the use of, or for damages resulting from the use of, any information, apparatus, method, or process disclosed.

VENTING REQUIREMENTS FOR CATEGORY I APPLIANCES

I. INTRODUCTION

This booklet contains the current definitions, instructions, and tables necessary to vent today's modern Category I Gas Fired Appliance. A variety of definitions of new terms describing today's gas appliances are included to supplement the actual venting tables which have been generated to correctly vent various combinations of Category I Appliances using Type B or single-wall metal vent connectors attached to Type B vents or masonry chimneys. Tables are also included covering similar venting material combinations when applied to common venting arrangements of two or more appliances.

Finally, a series of examples are presented demonstrating how the vent tables are used to size the vent connector and the vertical vent for a variety of typical applications.

II. DEFINITION OF TERMS

"Fan Assisted Combustion System"

An appliance equipped with an integral mechanical means to either draw or force products of combustion through the combustion chamber and/or heat exchanger.

"FAN Min"

refers to the minimum appliance input rating of a Category I appliance with a fan-assisted combustion system that could be attached to the vent.

"FAN Max"

refers to the maximum appliance input rating of a Category I appliance with a fan-assisted combustion system that could be attached to the vent.

"NAT Max"

refers to the maximum appliance input rating of a Category I appliance equipped with a draft hood that could be attached to the vent. There are no minimum appliance input ratings for draft hood-equipped appliances.

"FAN+FAN"

refers to the maximum combined input rating of two or more fan-assisted appliances attached to the common vent.

"FAN+NAT"

refers to the maximum combined input rating of one or more fan-assisted appliance and one or more draft hood-equipped appliance attached to the common vent.

"NAT+NAT"

refers to the maximum combined input rating of two or more draft hood-equipped appliances attached to the common vent.

"NR"

means not recommended due to potential for condensate formation and/or pressurization of the venting system.

"NA"

means not applicable due to physical or geometric constraints.

DraftHood

A device built into an appliance, or made a part of the vent connector from an appliance, which is designed to (1) provide for the ready escape of the flue gases from the appliance in the event of no draft, backdraft, or stoppage beyond the draft hood, (2) prevent a backdraft from entering the appliance, and (3) neutralize the effect of stack action of the chimney or gas vent upon the operation of the appliance.

Vent

A passageway used to convey flue gases from gas utilization equipment, or their vent connectors, to the outside atmosphere.

Vent Connector

The pipe or duct which connects a fuel-gas burning appliance to a vent or chimney.

Flue Collar

That portion of an appliance designed for the attachment of a draft hood, vent connector, or venting system.

Categorized Vent Diameter

The minimum vent diameter permissible for Category I appliances to maintain a nonpositive vent static pressure when tested in accordance with nationally recognized standards.

III. GENERAL VENTING REQUIREMENTS

All requirements contained in this document apply to both Category I draft hood equipped and fan-assisted combustion appliances. At no time should a venting system for a listed Category II, III, or IV appliance be sized with these Tables. The alternate sizing methods described in the National Fuel Gas Code (NFPA54/ANSI Z223.1-1988) may also be used to size the venting system for a draft hood equipped appliance. At this time, alternate sizing methods have not been developed for fan-assisted appliances. Therefore, until engineering data is developed to allow alternate sizing methods for Category I fan-assisted appliances, the vent tables must be used.

- 1) The venting tables included in this instruction apply to vents and chimneys internal to the structure below the roof line. Exterior chimneys or vents not enclosed by the structure or a chase below the roof line may experience continuous condensation depending on locality. Consult local gas utility, appliance manufacturer and/or local codes. A chimney with one or more sides exposed to the outside of the structure is considered to be an exterior chimney. A Type B or listed chimney lining system passing through an unused masonry chimney flue is not considered to be exposed to the outdoors
- 2) If the vent or connector size determined from the tables is smaller than the appliance draft hood outlet or flue collar, the smaller size may be used provided:
 - a) The total vent height "H" is at least 10 FT.
 - b) Vents or connectors for appliance draft hood outlets or flue collars 12 inches in diameter or smaller are not reduced more than one table size (e.g. 12 inches to 10 inches is a one size reduction).
 - c) Vents or connectors for appliance draft hood or flue collars above 12 inches in diameter are not reduced more than two table sizes (e.g. 24 inches to 20 inches is a two size reduction).
 - d) The maximum capacity listed in the tables for a fan-assisted appliance is reduced by 10% (0.90 x maximum capacity).
 - e) The draft hood outlet is greater than 4 inches in diameter. Do not connect a 3 inch diameter vent or connector to a 4 inch diameter draft hood outlet. This provision does not apply to fan-assisted appliances.

- 3) Single appliance venting configurations with zero lateral lengths, Tables 1 & 2, are assumed to have no elbows in the vent system. For all other vent configurations, the vent system is assumed to have two 90° elbows. For each additional 90° elbow, or equivalent* beyond two, the maximum capacity listed in the venting table should be reduced by 10 percent (0.90 x maximum listed capacity).

* Two 45° elbows are equivalent to one 90° elbow.

- 4) The common venting Tables 3, 4, 7, & 8 were generated using a maximum horizontal vent connector length of 1 1/2 feet (18 inches) for each inch of connector diameter as follows:

CONNECTOR DIAMETER (INCHES)	MAXIMUM HORIZONTAL CONNECTOR LENGTH (FEET)
3	4 1/2
4	6
5	7 1/2
6	9
7	10 1/2
8	12
9	13 1/2
10	15
12	18
14	21
16	24
18	27
20	30
22	33
24	36

The vent connector should be routed to the vent utilizing the shortest possible route. Connectors with longer horizontal lengths than those listed above are possible under the following conditions:

- a. The maximum capacity (Fan Max. or Nat Max.) of the vent connector shall be reduced 10% for each additional multiple of the length listed above. For example, the maximum length listed above for a 4 inch connector is 6 feet. With a connector length greater than 6 feet but not exceeding 12 feet, the maximum capacity must be reduced by 10% (0.90 x maximum vent connector capacity). With a connector length greater than 12 feet but not exceeding 18 feet, the maximum capacity must be reduced by 20% (0.80 x maximum vent capacity).

b. The minimum capacity (Fan Min.) shall be determined by referring to the corresponding single appliance table (Tables 1 and 2). In this case, for each appliance the entire vent connector and common vent from the appliance to the vent termination would be treated as a single appliance vent, as if the other appliances were not present.

5) If vent connectors are combined prior to entering the common vent, the maximum common vent capacity listed in the common venting tables must be reduced by 10%, the equivalent of 1 (one) 90° elbow (0.90 x maximum common vent capacity). See Figure 7: The horizontal length of the common vent connect or manifold (L) should not exceed 1-1/2 feet (18 inches) for each inch of common vent connector manifold diameter.

6) If the common vertical vent is offset as shown in Figure 8, the maximum common vent capacity listed in the common venting tables should be reduced by 20%, the equivalent of 2 (two) 90° elbows (0.80 x maximum common vent capacity). The horizontal length of the offset shall not exceed 1 1/2 feet for each inch of common vent diameter.

7) The common vent diameter must always be at least as large as the largest vent connector diameter. All interconnection fittings must also be the same size as the common vent.

8) Type B gas vents shall terminate above the roof surface with a listed cap or a listed roof assembly in accordance with the terms of their respective listings and the vent manufacturer's instructions.

VENT CAPS 12" AND SMALLER

Listed gas venting systems using listed vent caps 12" and smaller in size may terminate in accordance with the VENT TERMINATION TABLE. (SEE FIGURE 1)

VENT CAPS LARGER THAN 12"

Listed vent caps larger than 12" must be located at least 2 feet above the highest point and at least 2 feet higher than any portion of a building within a horizontal distance of 10 Feet. (SEE FIGURE 2)

9) Use sea level input rating when determining maximum capacity for high altitude installation. Use actual input rating for determining minimum capacity for high altitude installation.

GAS VENT TERMINATION TABLE

ROOF PITCH	MINIMUM HEIGHT
FLAT TO 7/12	1.0 FEET *
OVER 7/12 TO 8/12	1.5 FEET
OVER 8/12 TO 9/12	2.0 FEET
OVER 9/12 TO 10/12	2.5 FEET
OVER 10/12 TO 11/12	3.25 FEET
OVER 11/12 TO 12/12	4.0 FEET
OVER 12/12 TO 14/12	5.0 FEET
OVER 14/12 TO 16/12	6.0 FEET
OVER 16/12 TO 18/12	7.0 FEET
OVER 18/12 TO 20/12	7.5 FEET
OVER 20/12 TO 21/12	8.0 FEET

* THIS REQUIREMENT COVERS MOST INSTALLATIONS

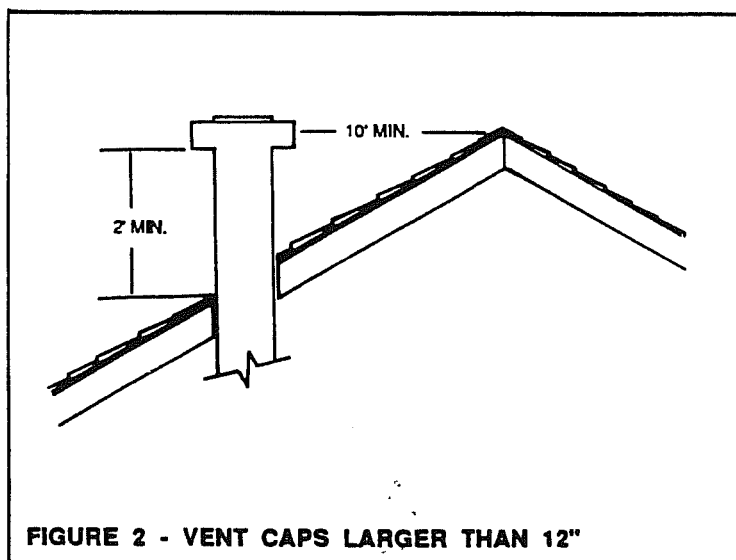
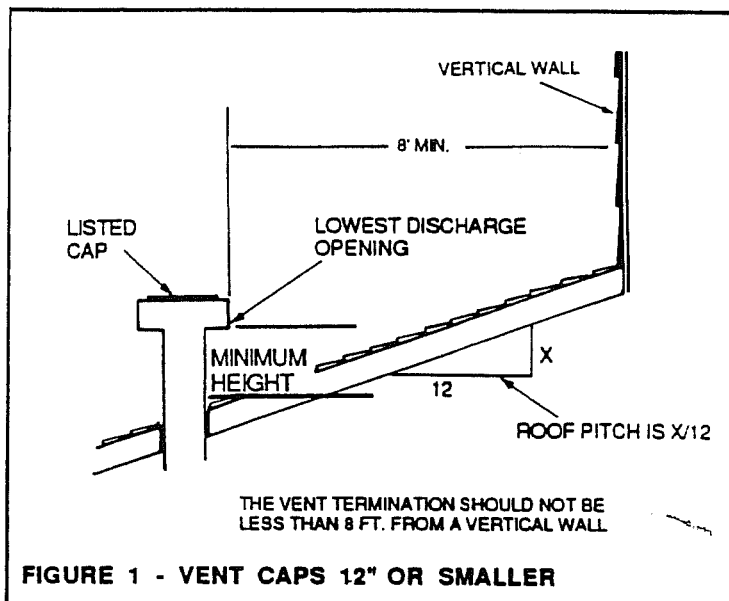

- 10) No portion of the venting system can extend into, or pass through any circulating air duct or plenum.
- 11) All vent pipe passing through floors, walls, and ceilings must be installed with the listed clearance to combustible materials and be fire stopped according to local codes. In the absence of local codes, refer to NFGC (Z223.1)
- 12) Vent connectors serving Category I appliances shall not be connected to any portion of mechanical draft systems operating under positive pressure such as Category III or IV Venting Systems.
- 13) A Category I appliance must never be connected to a chimney that is servicing a solid fuel appliance. If a fireplace chimney flue is used to vent this appliance, the fireplace opening must be permanently sealed.
- 14) A vent connector shall be supported without any dips or sags and shall slope a minimum of 1/4 inch per lineal foot of connector, back towards the appliance.
- 15) Vent connectors shall be firmly attached to draft hood outlets or flue collars by sheet-metal screws or other approved means, except vent connectors of listed Type B vent material which shall be assembled in accordance with the manufacturer's instructions. Joints between sections of single wall connector piping shall be fastened by sheet-metal screws or other approved means.
- 16) When the vent connector used for Category I appliances must be located in or pass through a crawl space or other area which may be cold, that portion of the vent connector shall be of listed double-wall Type B vent material or material having equivalent insulation qualities.
- 17) The entire length of single wall metal vent connector shall be readily accessible for inspection, cleaning, and replacement.
- 18) For appliances with more than one input rate, the minimum vent or connector (Fan Min) capacity determined from the tables shall be less than the lowest appliance input rating and the maximum vent or connector (Fan or Nat Max.) capacity determined from the tables shall be greater than the highest appliance input rating.

19) For single appliance vents:

- a) If the vertical vent or tile lined chimney has a larger diameter or flow area than the vent connector, use the vertical vent diameter to determine the minimum vent capacity and the vent connector diameter to determine the maximum vent capacity. The flow area of the vertical vent, however, shall not exceed 7 times the flow area of the listed appliance categorized vent area, draft hood outlet area or flue collar area unless designed in accordance with approved engineering methods. See Table 9 for calculated areas.

b) For multiple appliance vents:

The flow area of the largest section of vertical vent or chimney shall not exceed 7 times the smallest listed appliance categorized vent area, flue collar area, or draft hood outlet area unless designed in accordance with approved engineering methods. See Table for calculated areas.

$$\text{Maximum vent or tile lined chimney flow area} = \frac{\pi(D^*)^2}{4} \times 7$$

* Draft hood outlet diameter, flue collar diameter, or listed appliance categorized vent diameter.

- c) In no case, shall the vent connector be upsized more than 2 consecutive table size diameters over the size of the draft hood outlet, flue collar outlet, or listed appliance categorized vent. **Example:** An appliance with a 4 inch diameter flue outlet collar or draft hood outlet cannot be vented with a connector diameter larger than 6 inches.

20) Masonry chimneys used to vent Category I central furnaces must be either tile-lined or lined with a listed metal lining system or dedicated gas vent. Unlined masonry chimneys are prohibited. (See Note 1).

21) A fan assisted furnace may be common vented into an existing masonry chimney provided:

- a. The chimney is currently serving at least one draft hood equipped appliance.
- b. The vent connectors and chimney are sized in accordance with Tables 7 & 8.

SINGLE APPLIANCE VENTING OF A FAN ASSISTED FURNACE INTO A TILE LINED, MASONRY CHIMNEY IS PROHIBITED. THE CHIMNEY MUST FIRST BE LINED WITH EITHER TYPE B VENT SIZED IN ACCORDANCE WITH TABLES 1 OR 2 OR A LISTED, SINGLE WALL, METAL LINING SYSTEM, SIZED IN ACCORDANCE WITH NOTE 22.

- 22) Listed, corrugated metallic chimney liner systems in masonry chimneys shall be sized by using Tables 1 or 2 for dedicated venting and Tables 3 or 4 for common venting with the maximum capacity reduced by 0.20% (0.80 x maximum capacity) and the minimum capacity as shown in the applicable table. Corrugated metal vent systems installed with bends or offsets require additional reduction of the vent maximum capacity (See Note 6).
- 23) For multiple units of gas utilization equipment all located on one floor, available total height "H" is measured from the highest drafthood outlet or flue collar up to the level of the cap or terminal. Connector rise "R" is measured from the drafthood outlet or flue collar to the level where the vent gas streams come together. (Not applicable to multi-story).
- 24) For multi-story installations, available total height for each segment of the system "H" is the vertical distance between the highest drafthood outlet or flue collar entering that segment and the centerline of the next higher interconnection tee (See Figure 13).
- 25) The size of the lowest connector and of the vertical vent leading to the lowest interconnection of a multi-story system must be in accordance with Table 1 OR 2, for available total height "H" up to the lowest interconnection (See Figure 14).
- 26) Common vents in multi-story systems shall be type B when used in multi-story systems and have no offsets
- 27) Numbers followed by an asterisk (*) in Table 6, indicate the possibility of continuous condensation, depending on locality. Consult appliance manufacturer, local serving gas supplier, and/or authority having jurisdiction.
- 28) In a single run of vent or vent connector, more than one diameter and type of pipe are permitted to be used, provided that all the size are permitted by the tables.
- 29) If the desired vent height and connector rise and/or lateral are between the table entries, linear interpolation is permitted for calculation of the permissible appliance input ratings. Extrapolation beyond the table entries is not recommended. (See Example 7)
- 30) All combinations of pipe sizes, single-wall, and double-wall metal pipe are allowed within any connector run(s) or within the common vent provided ALL of the appropriate tables permit ALL of the desired sizes and types of pipe, as if they were used for the entire length of the subject connector or vent. If single-wall and Type B double-wall metal pipe are used for vent connectors, the common vent must be sized using Table 4.
- 31) Locate draft hood outlet or flue collar of smallest input appliance closest to or under common vent.
- 32) When vent table permits more than one diameter of pipe to be used for a connector or vent, the smallest permitted diameter should be preferred.

TYPICAL VENTING APPLICATIONS

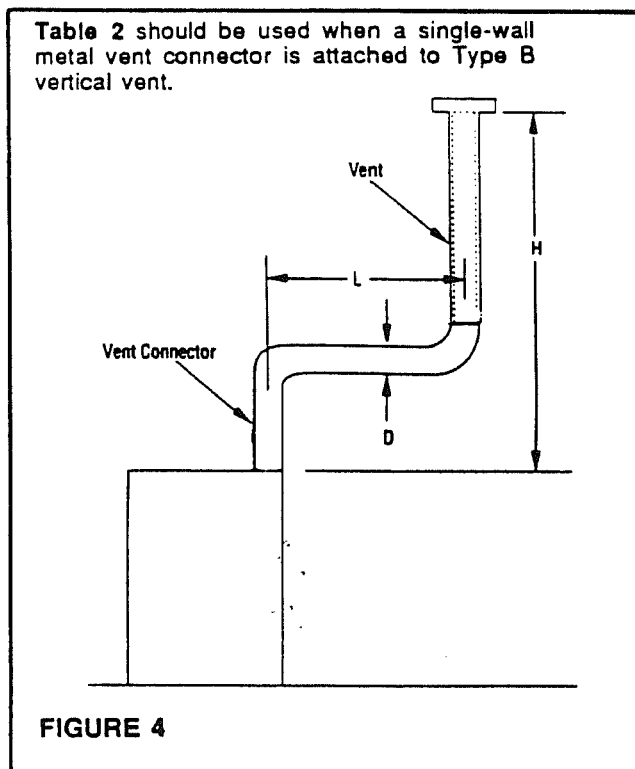
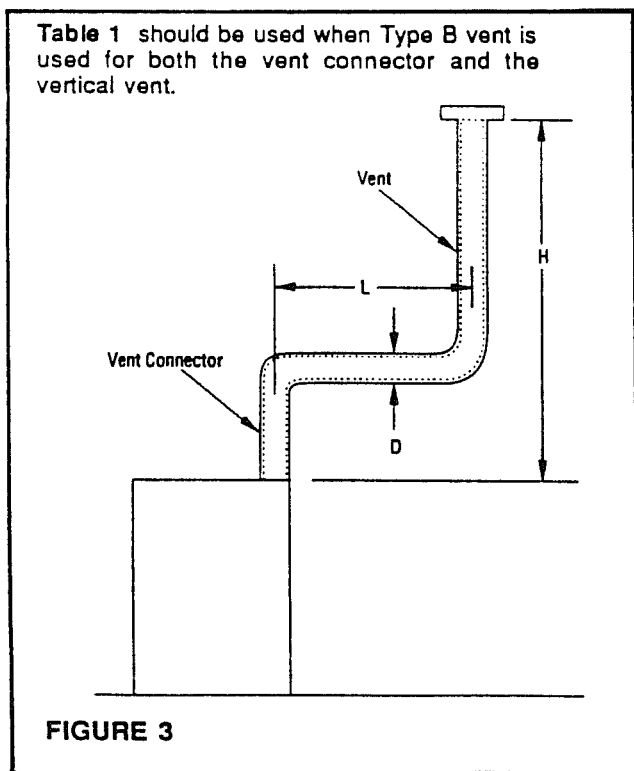

Table 3 should be used when Type B vent connectors are attached to a Type B common vent.

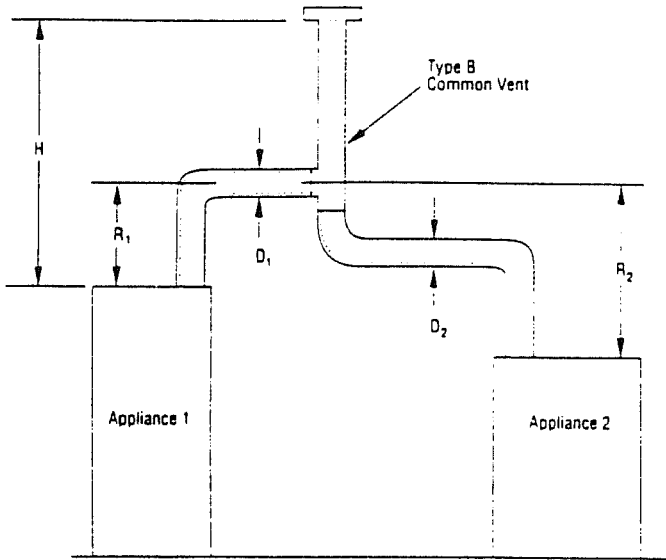

FIGURE 5

Table 4 should be used when single-wall metal vent connectors are attached to a Type B common vent.

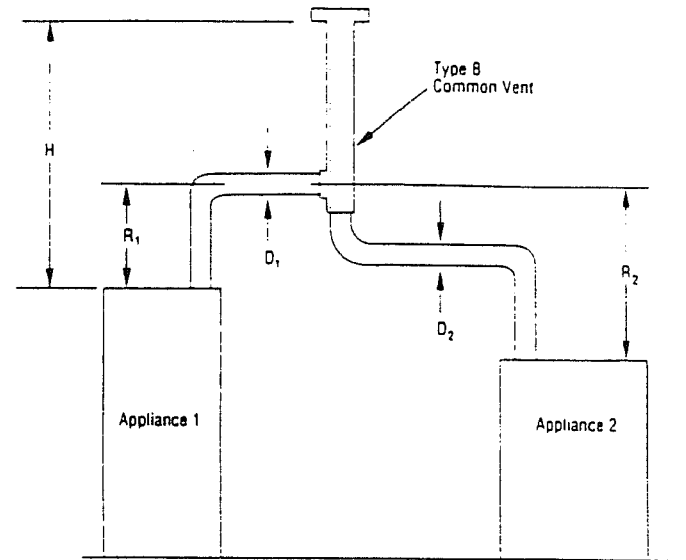

FIGURE 6

Schematic Diagram showing a typical manifolded common vent section "L" of the vent connector. (See Note 5)

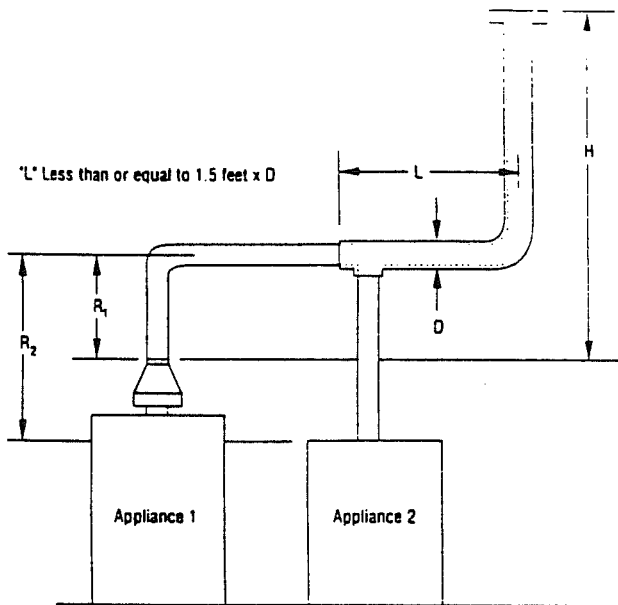

FIGURE 7

Schematic Diagram showing offset in the common vent section of the vertical vent. (See Note 6)

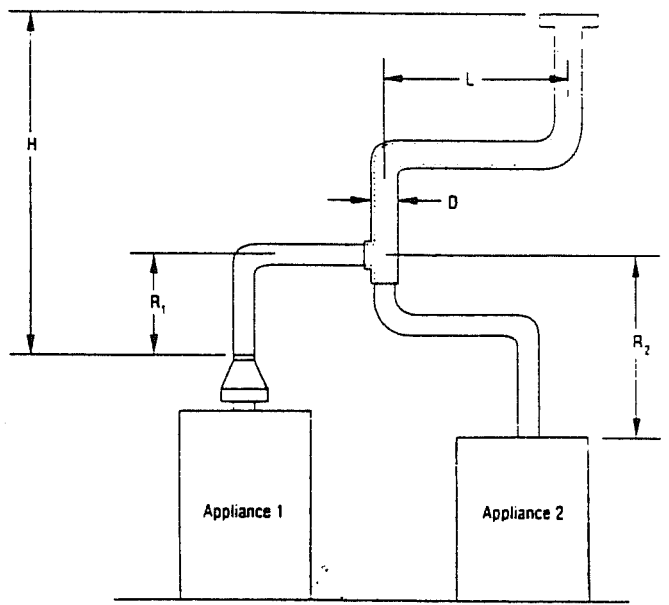

FIGURE 8

Table 5 shall be used when a Type B, double-wall vent connector is attached to a tile lined masonry chimney.

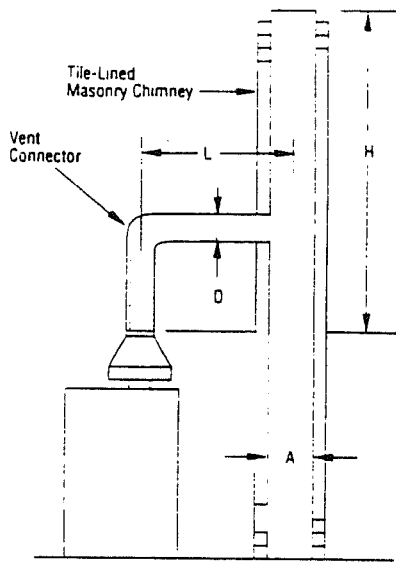

FIGURE 9

Table 6 shall be used when a single-wall metal vent connector is attached to a tile lined masonry chimney.

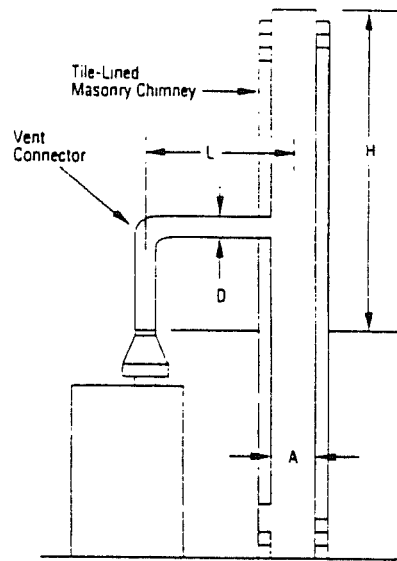

FIGURE 10

Table 7 shall be used when Type B double wall vent connectors are attached to a tile lined masonry chimney.

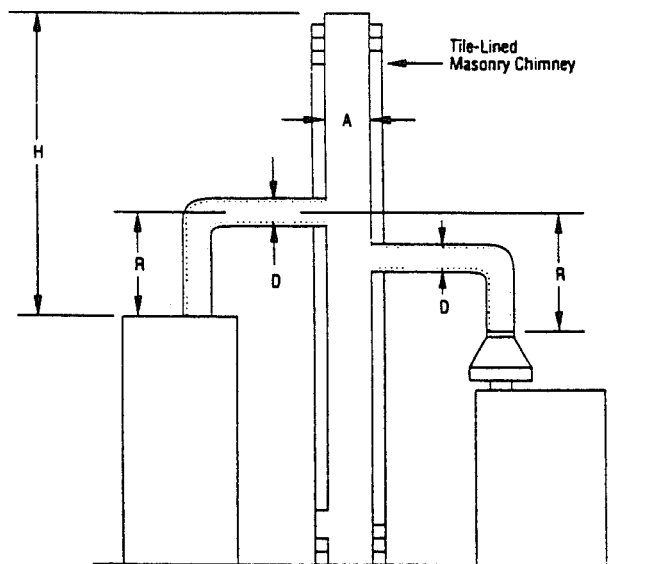

FIGURE 11

Table 8 shall be used when single-wall metal vent connectors are attached to a tile lined masonry chimney.

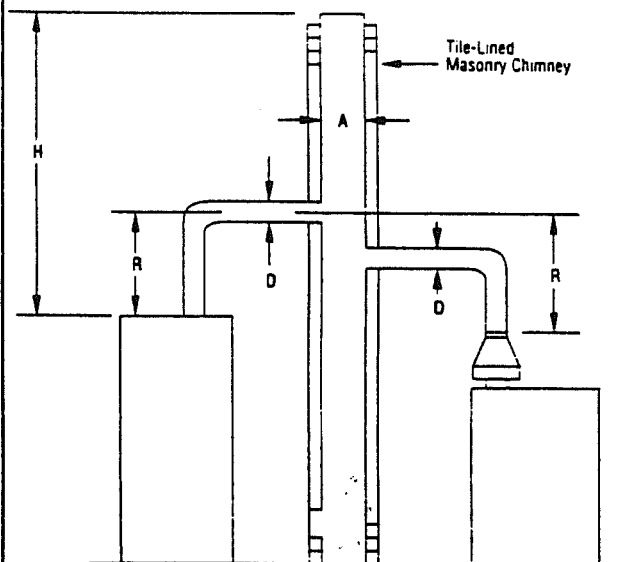

FIGURE 12

VENT TABLES

Capacity of Type B Double-Wall Vents with Type B Double-Wall Connectors
Serving a Single Category I Appliance

TABLE 1

Height Lateral H L (ft) (ft)		Vent and Connector Diameter - D (inches)																				
		3"			4"			5"			6"			7"			8"			9"		
		Appliance Input Rating in Thousands of Btu Per Hour																				
		FAN		NAT	FAN		NAT	FAN		NAT	FAN		NAT	FAN		NAT	FAN		NAT			
		Min	Max	Max	Min	Max	Max	Min	Max	Max	Min	Max	Max	Min	Max	Max	Min	Max	Max	Min	Max	Max
6	0	0	78	46	0	152	86	0	251	141	0	375	205	0	524	285	0	698	370	0	897	470
	2	13	51	36	18	97	67	27	157	105	32	232	157	44	321	217	53	425	285	63	543	370
	4	21	49	34	30	94	64	39	153	103	50	227	153	66	316	211	79	419	279	93	536	362
	6	25	46	32	36	91	61	47	149	100	59	223	149	78	310	205	93	413	273	110	530	354
8	0	0	84	50	0	165	94	0	276	155	0	415	235	0	583	320	0	780	415	0	1006	537
	2	12	57	40	16	109	75	25	178	120	28	263	180	42	365	247	50	483	322	60	619	418
	5	23	53	38	32	103	71	42	171	115	53	255	173	70	356	237	83	473	313	99	607	407
	8	28	49	35	39	98	66	51	164	109	64	247	165	84	347	227	99	463	303	117	596	396
10	0	0	88	53	0	175	100	0	295	166	0	447	255	0	631	345	0	847	450	0	1096	585
	2	12	61	42	17	118	81	23	194	129	26	289	195	40	402	273	48	533	355	57	684	457
	5	23	57	40	32	113	77	41	187	124	52	280	188	68	392	263	81	522	346	95	671	446
	10	30	51	36	41	104	70	54	176	115	67	267	175	88	376	245	104	504	330	122	651	427
15	0	0	94	58	0	191	112	0	327	187	0	502	285	0	716	390	0	970	525	0	1263	682
	2	11	69	48	15	136	93	20	226	150	22	339	225	38	475	316	45	633	414	53	815	544
	5	22	65	45	30	130	87	39	219	142	49	330	217	64	463	300	76	620	403	90	800	529
	10	29	59	41	40	121	82	51	206	135	64	315	208	84	445	288	99	600	386	116	777	507
15	35	53	37	48	112	76	61	195	128	76	301	198	98	429	275	115	580	373	134	755	491	
20	0	0	97	61	0	202	119	0	349	202	0	540	307	0	776	430	0	1057	575	0	1384	752
	2	10	75	51	14	149	100	18	250	166	20	377	249	33	531	346	41	711	470	50	917	612
	5	21	71	48	29	143	96	38	242	160	47	367	241	62	519	337	73	697	460	86	902	599
	10	28	64	44	38	133	89	50	229	150	62	351	228	81	499	321	95	675	443	112	877	576
	15	34	58	40	46	124	84	59	217	142	73	337	217	94	481	308	111	654	427	129	853	557
	20	48	52	35	55	116	78	69	206	134	84	322	206	107	464	295	125	634	410	145	830	537
30	0	0	100	64	0	213	128	0	374	220	0	587	336	0	853	475	0	1173	650	0	1548	855
	2	9	81	56	13	166	112	14	283	185	18	432	280	27	613	394	33	826	535	42	1072	700
	5	21	77	54	28	160	108	36	275	176	45	421	273	58	600	385	69	811	524	82	1055	688
	10	27	70	50	37	150	102	48	262	171	59	405	261	77	580	371	91	788	507	107	1028	668
	15	33	64	NR	44	141	96	57	249	163	70	389	249	90	560	357	105	765	490	124	1002	648
	20	56	58	NR	53	132	90	66	237	154	80	374	237	102	542	343	119	743	473	139	977	628
30	NR	NR	NR	73	113	NR	88	214	NR	104	346	219	131	507	321	149	702	444	171	929	594	
50	0	0	101	67	0	216	134	0	397	232	0	633	363	0	932	518	0	1297	708	0	1730	952
	2	8	86	61	11	183	122	14	320	206	15	497	314	22	715	445	26	975	615	33	1276	813
	5	20	82	NR	27	177	119	35	312	200	43	487	308	55	702	438	65	960	605	77	1259	798
	10	26	76	NR	35	168	114	45	299	190	56	471	298	73	681	426	86	935	589	101	1230	773
	15	59	70	NR	42	158	NR	54	287	180	66	455	288	85	662	413	100	911	572	117	1203	747
	20	NR	NR	NR	50	149	NR	63	275	169	76	440	278	97	642	401	113	888	556	131	1176	722
30	NR	NR	NR	69	131	NR	84	250	NR	99	410	259	123	605	376	141	844	522	161	1125	670	
100	0	NR	NR	NR	0	218	NR	0	407	NR	0	665	400	0	997	560	0	1411	770	0	1908	1040
	2	NR	NR	NR	10	194	NR	12	354	NR	13	566	375	18	831	510	21	1155	700	25	1536	935
	5	NR	NR	NR	26	189	NR	33	347	NR	40	557	369	52	820	504	60	1141	692	71	1519	926
	10	NR	NR	NR	33	182	NR	43	335	NR	53	542	361	68	801	493	80	1118	679	94	1492	910
	15	NR	NR	NR	40	174	NR	50	321	NR	62	528	353	80	782	482	93	1095	666	109	1465	895
	20	NR	NR	NR	47	166	NR	59	311	NR	71	513	344	90	763	471	105	1073	653	122	1438	880
30	NR	NR	NR	NR	NR	NR	78	290	NR	92	483	NR	115	726	449	131	1029	627	149	1387	849	
50	NR	NR	NR	NR	NR	NR	NR	NR	NR	147	428	NR	180	651	405	197	944	575	217	1288	787	

VENT TABLES

Capacity of Type B Double-Wall Vents with Type B Double-Wall Connectors
Serving a Single Category I Appliance

TABLE 1 (Cont'd)

Height H (ft)		Lateral L (ft)		Vent and Connector Diameter - D (Inches)																							
				10"		12"		14"		16"		18"		20"		22"		24"									
				Appliance Input Rating in Thousands of Btu Per Hour																							
		FAN		NAT		FAN		NAT		FAN		NAT		FAN		NAT		FAN		NAT		FAN		NAT			
		Min	Max	Max	Min	Max	Max	Min	Max	Max	Min	Max	Max	Min	Max	Max	Min	Max	Max	Min	Max	Max	Min	Max	Max		
6	0	0	1121	570	0	1645	850	0	2267	1170	0	2983	1530	0	3802	1960	0	4721	2430	0	5737	2950	0	6853	3520		
	2	75	675	455	103	982	650	138	1346	890	178	1769	1170	225	2250	1480	296	2782	1850	360	3377	2220	426	4030	2670		
	4	110	668	445	147	975	640	191	1338	880	242	1761	1160	300	2242	1475	390	2774	1835	469	3370	2215	555	4023	2660		
	6	128	661	435	171	967	630	219	1330	870	276	1753	1150	341	2235	1470	437	2767	1820	523	3363	2210	618	4017	2650		
8	0	0	1261	660	0	1858	970	0	2571	1320	0	3399	1740	0	4333	2220	0	5387	2750	0	6555	3360	0	7838	4010		
	2	71	770	515	98	1124	745	130	1543	1020	168	2030	1340	212	2584	1700	278	3196	2110	336	3882	2560	401	4634	3050		
	5	115	758	503	154	1110	733	199	1528	1010	251	2013	1330	311	2563	1685	398	3180	2090	476	3863	2545	562	4612	3040		
	8	137	746	490	180	1097	720	231	1514	1000	289	2000	1320	354	2552	1670	450	3163	2070	537	3850	2530	630	4602	3030		
10	0	0	1377	720	0	2036	1060	0	2825	1450	0	3742	1925	0	4782	2450	0	5955	3050	0	7254	3710	0	8682	4450		
	2	68	852	560	93	1244	850	124	1713	1130	161	2256	1480	202	2868	1890	264	3556	2340	319	4322	2840	378	5153	3390		
	5	112	839	547	149	1229	829	192	1696	1105	243	2238	1461	300	2849	1871	382	3536	2318	458	4301	2818	540	5132	3371		
	10	142	817	525	187	1204	795	238	1669	1080	298	2209	1430	364	2818	1840	459	3504	2280	546	4268	2780	641	5099	3340		
15	0	0	1596	840	0	2380	1240	0	3323	1720	0	4423	2270	0	5678	2900	0	7099	3620	0	8665	4410	0	10393	5300		
	2	63	1019	675	86	1495	985	114	2062	1350	147	2719	1770	186	3467	2260	239	4304	2800	290	5232	3410	346	6251	4080		
	5	105	1003	660	140	1476	967	182	2041	1327	229	2696	1748	283	3442	2235	355	4278	2777	426	5204	3385	501	6222	4057		
	10	135	977	635	177	1446	936	227	2009	1289	283	2659	1712	346	3402	2193	432	4234	2739	510	5159	3343	599	6175	4019		
	15	155	953	610	202	1418	905	257	1976	1250	318	2623	1675	385	3363	2150	479	4192	2700	564	5115	3300	665	6129	3980		
20	0	0	1756	930	0	2637	1350	0	3701	1900	0	4948	2520	0	6376	3250	0	7988	4060	0	9785	4980	0	11753	6000		
	2	59	1150	755	81	1694	1100	107	2343	1520	139	3097	2000	175	3955	2570	220	4916	3200	269	5983	3910	321	7154	4700		
	5	101	1133	738	135	1674	1079	174	2320	1498	219	3071	1978	270	3926	2544	337	4885	3174	403	5950	3880	475	7119	4662		
	10	130	1105	710	172	1641	1045	220	2282	1460	273	3029	1940	334	3880	2500	413	4835	3130	489	5896	3830	573	7083	4600		
	15	150	1078	688	195	1609	1018	248	2245	1425	306	2988	1910	372	3835	2465	459	4786	3090	541	5844	3795	631	7007	4575		
	20	167	1052	665	217	1578	990	273	2210	1390	335	2948	1880	404	3791	2430	495	4737	3050	585	5792	3760	689	6953	4550		
30	0	0	1977	1060	0	3004	1550	0	4252	2170	0	5725	2920	0	7420	3770	0	9341	4750	0	11483	5850	0	13848	7060		
	2	54	1351	865	74	2004	1310	98	2786	1800	127	3696	2380	159	4734	3050	199	5900	3810	241	7194	4650	285	8617	5600		
	5	96	1332	851	127	1981	1289	164	2759	1775	206	3666	2350	252	4701	3020	312	5863	3783	373	7155	4622	439	8574	5552		
	10	125	1301	829	164	1944	1254	209	2716	1733	259	3617	2300	316	4647	2970	386	5803	3739	456	7090	4574	535	8505	5471		
	15	143	1272	807	187	1908	1220	237	2674	1692	292	3570	2250	354	4594	2920	431	5744	3695	507	7026	4527	590	8437	5391		
	20	160	1243	784	207	1873	1185	260	2633	1650	319	3523	2200	384	4542	2870	467	5686	3650	548	6964	4480	639	8370	5310		
	30	195	1189	745	246	1807	1130	305	2555	1585	369	3433	2130	440	4442	2785	540	5574	3565	635	6842	4375	739	8239	5225		
50	0	0	2231	1195	0	3441	1825	0	4934	2550	0	6711	3440	0	8774	4460	0	11129	5635	0	13767	6940	0	16694	8430		
	2	41	1620	1010	66	2431	1513	86	3409	2125	113	4554	2840	141	5864	3670	171	7339	4630	209	8980	5695	251	10788	6860		
	5	90	1600	996	118	2406	1495	151	3380	2102	191	4520	2813	234	5826	3639	283	7295	4597	336	8933	5654	394	10737	6818		
	10	118	1567	972	154	2366	1466	196	3332	2064	243	4464	2767	295	5763	3585	355	7224	4542	419	8855	5585	491	10652	6749		
	15	136	1536	948	177	2327	1437	222	3285	2026	274	4409	2721	330	5701	3534	396	7155	4511	465	8779	5546	542	10570	6710		
	20	151	1505	924	195	2288	1408	244	3239	1987	300	4356	2675	361	5641	3481	433	7086	4479	506	8704	5506	586	10488	6670		
	30	183	1446	876	232	2214	1349	287	3150	1910	347	4253	2631	412	5523	3431	494	6953	4421	577	8557	5444	672	10328	6603		
100	0	0	2491	1310	0	3925	2050	0	5729	2950	0	7914	4050	0	10485	5300	0	13454	6700	0	16817	8600	0	20578	10300		
	2	30	1975	1170	44	3027	1820	72	4313	2550	95	5834	3500	120	7591	4600	138	9577	5800	169	11803	7200	204	14264	8800		
	5	82	1955	1159	107	3002	1803	136	4282	2531	172	5797	3475	208	7548	4566	245	9528	5769	293	11748	7162	341	14204	8756		
	10	108	1923	1142	142	2961	1775	180	4231	2500	223	5737	3434	268	7478	4509	318	9447	5717	374	11658	7100	436	14105	8683		
	15	126	1892	1124	163	2920	1745	206	4182	2469	252	5678	3392	304	7409	4451	358	9367	5665	418	11569	7037	487	14007	8610		
	20	141	1861	1107	181	2880	1719	226	4133	2438	277	5619	3351	330	7341	4394	387	9289	5613	452	11482	6975	523	13910	8537		
	30	170	1802	1071	215	2803	1663	265	4037	2375	319	5505	3267	378	7209	4279	446	9136	5509	514	11310	6850	592	13720	8391		
	50	241	1688	1000	292	2657	1550	350	3856	2250	415	5289	3100	486	6956	4050	572	8841	5300	659	10979	6600	752	13354	8100		

VENT TABLES

Capacity of Type B Double-Wall Vents with Single-Wall Metal Connectors
Serving a Single Category I Appliance

TABLE 2

Height H (ft)		Lateral L (ft)		Vent and Connector Diameter - D (Inches)																																					
				3"			4"			5"			6"			7"			8"			9"			10"			12"													
				Appliance Input Rating in Thousands of Btu Per Hour																																					
FAN			NAT			FAN			NAT			FAN			NAT			FAN			NAT			FAN			NAT			FAN			NAT			FAN			NAT		
Min Max Max			Min Max Max			Min Max Max			Min Max Max			Min Max Max			Min Max Max			Min Max Max			Min Max Max			Min Max Max			Min Max Max			Min Max Max			Min Max Max			Min Max Max			Min Max Max		
6	0	38	77	45	59	151	85	85	249	140	126	373	204	165	522	284	211	695	369	267	894	469	371	1118	569	537	1639	849													
	2	39	51	36	60	96	66	85	156	104	123	231	156	159	320	213	201	423	284	251	541	368	347	673	453	498	979	648													
	4	NR	NR	33	74	92	63	102	152	102	146	225	152	187	313	208	237	416	277	295	533	360	409	664	443	584	971	638													
	6	NR	NR	31	83	89	60	114	147	99	163	220	148	207	307	203	263	409	271	327	526	352	449	656	433	638	962	627													
8	0	37	83	50	58	164	93	83	273	154	123	412	234	161	530	319	206	777	414	258	1002	536	360	1257	658	521	1852	967													
	2	39	56	39	59	108	75	83	176	119	121	261	179	155	363	246	197	482	321	246	617	417	339	768	513	486	1120	743													
	5	NR	NR	37	77	102	69	107	168	114	151	252	171	193	352	235	245	470	311	305	604	404	418	754	500	598	1104	730													
	8	NR	NR	33	90	95	64	122	161	107	175	243	163	223	342	225	280	458	300	344	591	392	470	740	486	665	1089	715													
10	0	37	87	53	57	174	99	82	293	165	120	444	254	158	628	344	202	844	449	253	1093	584	351	1373	718	507	2031	1057													
	2	39	61	41	59	117	80	82	193	128	119	287	194	153	400	272	193	531	354	242	681	456	332	849	559	475	1242	848													
	5	52	56	39	76	111	76	105	185	122	148	277	186	190	388	261	241	518	344	299	667	443	409	834	544	584	1224	825													
	10	NR	NR	34	97	100	68	132	171	112	188	261	171	237	369	241	296	497	325	363	643	423	492	808	520	688	1194	788													
15	0	36	93	57	56	190	111	80	325	186	116	499	283	153	713	388	195	966	523	244	1259	681	336	1591	838	488	2374	1237													
	2	38	69	47	57	136	93	80	225	149	115	337	224	148	473	314	187	631	413	232	812	543	319	1015	673	457	1491	983													
	5	51	63	44	75	128	86	102	216	140	144	326	217	182	459	298	231	616	400	287	795	526	392	997	657	562	1469	963													
	10	NR	NR	39	95	116	79	128	201	131	182	308	203	228	438	284	284	592	381	349	768	501	470	966	628	664	1433	928													
	15	NR	NR	NR	NR	NR	72	158	186	124	220	290	192	272	418	269	334	568	367	404	742	484	540	937	601	750	1399	894													
20	0	35	96	60	54	200	118	78	346	201	114	537	306	149	772	428	190	1053	573	238	1379	750	326	1751	927	473	2631	1346													
	2	37	74	50	56	148	99	78	248	165	113	375	248	144	528	344	182	708	468	227	914	611	309	1146	754	443	1689	1098													
	5	50	68	47	73	140	94	100	239	158	141	363	239	178	514	334	224	692	457	279	896	596	381	1126	734	547	1688	1074													
	10	NR	NR	41	93	129	86	125	223	146	177	344	224	222	491	316	277	666	437	339	866	570	457	1092	707	646	1626	1037													
	15	NR	NR	NR	NR	NR	80	155	208	136	216	325	210	264	469	301	325	640	419	393	838	549	526	1060	677	730	1587	1005													
	20	NR	NR	NR	NR	NR	NR	186	192	126	254	306	196	369	448	285	374	616	400	448	810	526	592	1028	651	808	1550	973													
30	0	34	99	63	53	211	127	76	372	219	110	584	334	144	849	472	184	1168	647	229	1542	852	312	1971	1056	454	2996	1545													
	2	37	80	56	55	164	111	76	281	183	109	429	279	139	610	392	175	823	533	219	1069	698	296	1346	863	424	1999	1308													
	5	49	74	52	72	157	106	98	271	173	136	417	271	171	595	382	215	806	521	269	1049	684	366	1324	846	524	1971	1283													
	10	NR	NR	NR	91	144	98	122	255	168	171	397	257	213	570	367	265	777	501	327	1017	662	440	1287	821	620	1927	1243													
	15	NR	NR	NR	115	131	NR	151	239	157	208	377	242	255	547	349	312	750	481	379	985	638	507	1251	794	702	1884	1205													
	20	NR	NR	NR	NR	NR	NR	181	223	NR	246	357	228	298	524	333	360	723	461	433	955	615	570	1216	768	780	1841	1166													
	30	NR	NR	NR	NR	NR	NR	NR	NR	NR	NR	NR	NR	389	477	305	461	670	426	541	895	574	704	1147	720	937	1759	1101													
50	0	33	99	66	51	213	133	73	394	230	105	629	361	138	928	515	176	1292	704	220	1724	948	295	2223	1189	428	3432	1818													
	2	36	84	61	53	181	121	73	318	205	104	495	312	133	712	443	168	971	613	209	1273	811	280	1615	1007	401	2426	1509													
	5	48	80	NR	70	174	117	94	308	198	131	482	305	164	696	435	204	953	602	257	1252	795	347	1591	991	496	2396	1490													
	10	NR	NR	NR	89	160	NR	118	292	186	162	461	292	203	671	420	253	923	583	313	1217	765	418	1551	963	589	2347	1455													
	15	NR	NR	NR	112	148	NR	145	275	174	199	441	280	244	646	405	299	894	562	363	1183	736	481	1512	934	668	2299	1421													
	20	NR	NR	NR	NR	NR	NR	176	257	NR	236	420	267	285	622	389	345	866	543	415	1150	708	544	1473	906	741	2251	1387													
	30	NR	NR	NR	NR	NR	NR	NR	NR	NR	315	376	NR	373	573	NR	442	809	502	521	1086	649	674	1399	848	892	2159	1318													
100	0	NR	NR	NR	49	214	NR	69	403	NR	100	659	395	131	991	555	166	1404	765	207	1900	1033	273	2479	1300	395	3912	2042													
	2	NR	NR	NR	51	192	NR	70	351	NR	98	563	373	125	828	508	158	1152	698	196	1532	933	259	1970	1168	371	3021	1817													
	5	NR	NR	NR	67	186	NR	90	342	NR	125	551	366	156	813	501	194	1134	688	240	1511	921	322	1945	1153	460	2990	1796													
	10	NR	NR	NR	85	175	NR	113	324	NR	153	532	354	191	789	486	238	1104	672	293	1477	902	389	1905	1133	547	2938	1763													
	15	NR	NR	NR	132	162	NR	138	310	NR	188	511	343	230	764	473	281	1075	656	342	1443	884	447	1865	1110	618	2888	1730													
	20	NR	NR	NR	NR	NR	NR	168	295	NR	224	487	NR	270	739	458	325	1046	639	391	1410	864	507	1825	1087	690	2838	1696													
	30	NR	NR	NR	NR	NR	NR	231	264	NR	301	448	NR	355	685	NR	418	988	NR	491	1343	824	631	1747	1041	834	2739	1627													
	50	NR	NR	NR	NR	NR	NR	NR	NR	NR	NR	NR	NR	540	584	NR	617	866	NR	711	1205	NR	895	1591	NR	1138	2547	1489													

VENT TABLES

Capacity of Type B Double-Wall Vents with Type B Double-Wall Connectors
Serving Two or more Category I Appliances

TABLE 3

Vent Connector Capacity

Vent Height H (ft)		Connector Rise R (ft)		Vent Connector Diameter - D (Inches)																																		
				3"			4"			5"			6"			7"			8"			9"			10"													
				Appliance Input Rating Limits in Thousands of Btu Per Hour																																		
				FAN			NAT			FAN			NAT			FAN			NAT			FAN			NAT			FAN			NAT			FAN			NAT	
Min Max Max			Min Max Max			Min Max Max			Min Max Max			Min Max Max			Min Max Max			Min Max Max			Min Max Max			Min Max Max			Min Max Max			Min Max Max			Min Max Max			Min Max Max		
6	1	22	37	26	35	66	46	46	106	72	58	164	104	77	225	142	92	296	185	109	376	237	128	466	289													
	2	23	41	31	37	75	55	48	121	86	60	183	124	79	253	168	95	333	220	112	424	282	131	526	345													
	3	24	44	35	38	81	62	49	132	96	62	199	139	82	275	189	97	363	248	114	463	317	134	575	386													
8	1	22	40	27	35	72	48	49	114	76	64	176	109	84	243	148	100	320	194	118	408	248	138	507	303													
	2	23	44	32	36	80	57	51	128	90	66	195	129	86	269	175	103	356	230	121	454	294	141	564	358													
	3	24	47	36	37	87	64	53	139	101	67	210	145	88	290	198	105	384	258	123	492	330	143	612	402													
10	1	22	43	28	34	78	50	49	123	78	65	189	113	89	257	154	106	341	200	125	436	257	146	542	314													
	2	23	47	33	36	86	59	51	136	93	67	206	134	91	282	182	109	374	238	128	479	305	149	596	372													
	3	24	50	37	37	92	67	52	146	104	69	220	150	94	303	205	111	402	268	131	515	342	152	642	417													
15	1	21	50	30	33	89	53	47	142	83	64	220	120	88	298	163	110	389	214	134	493	273	162	609	333													
	2	22	53	35	35	96	63	49	153	99	66	235	142	91	320	193	112	419	253	137	532	323	165	658	394													
	3	24	55	40	36	102	71	51	163	111	68	248	160	93	339	218	115	445	286	140	565	365	167	700	444													
20	1	21	54	31	33	99	56	46	157	87	62	246	125	86	334	171	107	436	224	131	552	285	158	681	347													
	2	22	57	37	34	105	66	48	167	104	64	259	149	89	354	202	110	463	265	134	587	339	161	725	414													
	3	23	60	42	35	110	74	50	176	116	66	271	168	91	371	228	113	486	300	137	618	518	164	764	466													
30	1	20	62	33	31	113	59	45	181	93	60	288	134	83	391	182	103	512	238	125	649	305	151	802	372													
	2	21	64	39	33	118	70	47	190	110	62	299	158	85	408	215	105	535	282	129	679	360	155	840	439													
	3	22	66	44	34	123	79	48	198	124	64	309	178	88	423	242	108	555	317	132	706	405	158	874	494													
50	1	19	71	36	30	133	64	43	216	101	57	349	145	78	477	197	97	627	257	120	797	330	144	984	403													
	2	21	73	43	32	137	76	45	223	119	59	358	172	81	490	234	100	645	306	123	820	392	148	1014	478													
	3	22	75	48	33	141	86	46	229	134	61	366	194	83	502	263	103	661	343	126	842	441	151	1043	538													
100	1	18	82	37	28	158	66	40	262	104	53	442	150	73	611	204	91	810	266	112	1038	341	135	1285	417													
	2	19	83	44	30	161	79	42	267	123	55	447	178	75	619	242	94	822	316	115	1054	405	139	1306	494													
	3	20	84	50	31	163	89	44	272	138	57	452	200	78	627	272	97	834	355	118	1069	455	142	1327	555													

Common Vent Capacity

Vent Height H (ft)		Common Vent Diameter - D (Inches)																											
		4"			5"			6"			7"			8"			9"			10"									
		Combined Appliance Input Rating in Thousands of Btu Per Hour																											
		FAN			FAN			FAN			FAN			FAN			FAN			FAN			FAN			FAN			
+FAN			+FAN			+FAN			+FAN			+FAN			+FAN			+FAN			+FAN			+FAN			+FAN		
+NAT			+NAT			+NAT			+NAT			+NAT			+NAT			+NAT			+NAT			+NAT			+NAT		
+NAT			+NAT			+NAT			+NAT			+NAT			+NAT			+NAT			+NAT			+NAT			+NAT		
6	92	81	65	140	116	103	204	161	147	309	248	200	404	314	260	547	434	335	672	520	410								
8	101	90	73	155	129	114	224	178	163	339	275	223	444	348	290	602	480	378	740	577	465								
10	110	97	79	169	141	124	243	194	178	367	299	242	477	377	315	649	522	405	800	627	495								
15	125	112	91	195	164	144	283	228	206	427	352	280	556	444	365	753	612	465	924	733	565								
20	136	123	102	215	183	160	314	255	229	475	394	310	621	499	405	842	688	523	1035	826	640								
30	152	138	118	244	210	185	361	297	266	547	459	360	720	585	470	979	808	605	1209	975	740								
50	167	153	134	279	244	214	421	353	310	641	547	423	854	706	550	1164	977	705	1451	1188	860								
100	175	163	NR	311	277	NR	489	421	NR	751	658	479	1025	873	625	1408	1215	800	1784	1502	975								

VENT TABLES

TABLE 3 (cont'd)

Capacity of Type B Double-Wall Vents with Type B Double-Wall Connectors
Serving two or more Category I Appliances

Vent Connector Capacity

Vent Height H (ft)	Connector Rise R (ft)	Vent Connector Diameter - D (inches)																				
		12"			14"			16"			18"			20"			22"			24"		
		Appliance Input Rating Limits in Thousands of Btu Per Hour																				
		FAN		NAT	FAN		NAT	FAN		NAT	FAN		NAT	FAN		NAT	FAN		NAT	FAN		NAT
Min	Max	Max	Min	Max	Max	Min	Max	Max	Min	Max	Max	Min	Max	Max	Min	Max	Max	Min	Max	Max		
6	2	174	764	496	223	1046	653	281	1371	853	346	1772	1080	NA	NA	NA	NA	NA	NA	NA	NA	
	4	180	897	616	230	1231	827	287	1617	1081	352	2069	1370	NA	NA	NA	NA	NA	NA	NA	NA	
	6	NA	NA	NA	NA	NA	NA	NA	NA	NA	NA	NA	NA	NA	NA	NA	NA	NA	NA	NA	NA	
8	2	186	822	516	238	1126	696	298	1478	910	365	1920	1150	NA	NA	NA	NA	NA	NA	NA	NA	
	4	192	952	644	244	1307	884	305	1719	1150	372	2211	1460	471	2737	1800	560	3319	2180	662	3957	2590
	6	198	1050	772	252	1445	1072	313	1902	1390	380	2434	1770	478	3018	2180	568	3665	2640	669	4373	3130
10	2	196	870	536	249	1195	730	311	1570	955	379	2049	1205	NA	NA	NA	NA	NA	NA	NA	NA	
	4	201	997	664	256	1371	924	318	1804	1205	387	2332	1535	486	2887	1890	581	3502	2280	686	4175	2710
	6	207	1095	792	263	1509	1118	325	1989	1455	395	2556	1865	494	3169	2290	589	3849	2760	694	4593	3270
15	2	214	967	568	272	1334	790	336	1760	1030	408	2317	1305	NA	NA	NA	NA	NA	NA	NA	NA	
	4	221	1085	712	279	1499	1006	344	1978	1320	416	2579	1665	523	3197	2060	624	3881	2490	734	4631	2960
	6	228	1181	856	286	1632	1222	351	2157	1610	424	2796	2025	533	3470	2510	634	4216	3030	743	5035	3600
20	2	223	1051	596	291	1443	840	357	1911	1095	430	2533	1385	NA	NA	NA	NA	NA	NA	NA	NA	
	4	230	1162	748	298	1597	1064	365	2116	1395	438	2778	1765	554	3447	2180	661	4190	2630	772	5005	3130
	6	237	1253	900	307	1726	1288	373	2287	1695	450	2984	2145	567	3708	2650	671	4511	3190	785	5392	3790
30	2	216	1217	632	286	1664	910	367	2183	1190	461	2891	1540	NA	NA	NA	NA	NA	NA	NA	NA	
	4	223	1316	792	294	1802	1160	376	2366	1510	474	3110	1920	619	3840	2365	728	4681	2860	847	5606	3410
	6	231	1400	952	303	1920	1410	384	2524	1830	485	3299	2340	632	4080	2875	741	4976	3480	860	5961	4150
50	2	206	1479	689	273	2023	1007	350	2659	1315	435	3548	1665	NA	NA	NA	NA	NA	NA	NA	NA	
	4	213	1561	860	281	2139	1291	359	2814	1685	447	3730	2135	580	4601	2633	709	5569	3185	851	6633	3790
	6	221	1631	1031	290	2242	1575	369	2951	2055	461	3893	2605	594	4808	3208	724	5826	3885	867	6943	4620
100	2	192	1923	712	254	2644	1050	326	3490	1370	402	4707	1740	NA	NA	NA	NA	NA	NA	NA	NA	
	4	200	1984	888	263	2731	1346	336	3606	1760	414	4842	2220	523	5982	2750	639	7254	3330	769	8650	3950
	6	208	2035	1064	272	2811	1642	346	3714	2150	426	4968	2700	539	6143	3350	654	7453	4070	786	8892	4810

Common Vent Capacity

Vent Height H (ft)	Common Vent Diameter - D (inches)																				
	12"			14"			16"			18"			20"			22"			24"		
	Combined Appliance Input Rating in Thousands of Btu Per Hour																				
	FAN	FAN	NAT	FAN	FAN	NAT	FAN	FAN	NAT	FAN	FAN	NAT	FAN	FAN	NAT	FAN	FAN	NAT	FAN	FAN	NAT
+FAN	+NAT	+NAT	+FAN	+NAT	+NAT	+FAN	+NAT	+NAT	+FAN	+NAT	+NAT	+FAN	+NAT	+NAT	+FAN	+NAT	+NAT	+FAN	+NAT	+NAT	
6	900	696	588	1284	990	815	1735	1336	1065	2253	1732	1345	2838	2180	1660	3488	2677	1970	4206	3226	2390
8	994	773	652	1423	1103	912	1927	1491	1190	2507	1936	1510	3162	2439	1860	3890	2998	2200	4695	3616	2680
10	1076	841	712	1542	1200	995	2093	1625	1300	2727	2113	1645	3444	2665	2030	4241	3278	2400	5123	3957	2920
15	1247	986	825	1794	1410	1158	2440	1910	1510	3184	2484	1910	4026	3133	2360	4971	3862	2790	6016	4670	3400
20	1405	1116	916	2006	1588	1290	2722	2147	1690	3561	2798	2140	4548	3552	2640	5573	4352	3120	6749	5261	3800
30	1658	1327	1025	2373	1892	1525	3220	2558	1990	4197	3326	2520	5303	4193	3110	6539	5157	3680	7940	6247	4480
50	2024	1640	1280	2911	2347	1863	3964	3183	2430	5184	4149	3075	6567	5240	3800	8116	6458	4500	9837	7813	5475
100	2569	2131	1670	3732	3076	2450	5125	4202	3200	6749	5509	4050	8597	6986	5000	10681	8648	5920	13004	10499	7200

VENT TABLES

Capacity of Type B Double-Wall Vent with Single-Wall Connectors
Serving Two or more Category I Appliances

TABLE 4

Vent Connector Capacity

Vent Height H (ft)		Connector Rise R (ft)		Vent Connector Diameter - D (inches)																																								
				3"			4"			5"			6"			7"			8"			9"			10"																			
				Appliance Input Rating Limits in Thousands of Btu Per Hour																																								
				FAN			NAT			FAN			NAT			FAN			NAT			FAN			NAT			FAN			NAT			FAN			NAT							
Min			Max			Max			Min			Max			Max			Min			Max			Max			Min			Max			Max			Min			Max			Max		
6	1	NR	NR	26	NR	NR	46	NR	NR	71	NR	NR	102	207	223	140	262	293	183	325	373	234	447	463	286																			
	2	NR	NR	31	NR	NR	55	NR	NR	85	168	182	123	215	251	167	271	331	219	334	422	281	458	524	344																			
	3	NR	NR	34	NR	NR	62	121	131	95	174	198	138	222	273	188	279	361	247	344	462	316	468	574	385																			
15	1	NR	NR	29	79	87	52	116	138	81	177	214	116	238	291	158	312	380	208	397	482	266	556	596	324																			
	2	NR	NR	34	83	94	62	121	150	97	185	230	138	246	314	189	321	411	248	407	522	317	568	646	387																			
	3	NR	NR	39	87	100	70	127	160	109	193	243	157	255	333	215	331	438	281	418	557	360	579	690	437																			
30	1	47	60	31	77	110	57	113	175	89	169	278	129	226	380	175	296	497	230	378	630	294	528	779	358																			
	2	50	62	37	81	115	67	117	185	106	177	290	152	236	397	208	307	521	274	389	662	349	541	819	425																			
	3	54	64	42	85	119	76	122	193	120	185	300	172	244	412	235	316	542	309	400	690	394	555	855	482																			
50	1	46	69	33	75	128	60	109	207	96	162	336	137	217	460	188	284	604	245	364	768	314	507	951	384																			
	2	49	71	40	79	132	72	114	215	113	170	345	164	226	473	223	294	623	293	376	793	375	520	983	458																			
	3	53	72	45	83	136	82	119	221	128	178	353	186	235	486	252	304	640	331	387	816	424	535	1013	518																			

Common Vent Capacity

Vent Height H (ft)		Common Vent Diameter - D (inches)																								
		4"			5"			6"			7"			8"			9"			10"						
		Combined Appliance Input Rating in Thousands of Btu Per Hour																								
		FAN			FAN			FAN			FAN			FAN			FAN			FAN			FAN			FAN
+FAN			+FAN			+FAN			+FAN			+FAN			+FAN			+FAN			+FAN			+FAN		
+NAT			+NAT			+NAT			+NAT			+NAT			+NAT			+NAT			+NAT			+NAT		
+NAT			+NAT			+NAT			+NAT			+NAT			+NAT			+NAT			+NAT			+NAT		
6	89	78	64	136	113	100	200	158	144	304	244	196	398	310	257	541	429	332	665	515	407					
8	98	87	71	151	126	112	218	173	159	331	269	218	436	342	285	592	473	373	730	569	460					
10	106	94	76	163	137	120	237	189	174	357	292	236	467	369	309	638	512	398	787	617	487					
15	121	108	88	189	159	140	275	221	200	416	343	274	544	434	357	738	599	456	905	718	553					
20	131	118	98	208	177	155	305	247	223	463	383	302	606	487	395	824	673	512	1013	808	626					
30	145	132	113	236	202	179	350	286	257	533	446	349	703	570	459	958	790	593	1183	952	723					
50	159	145	128	268	233	204	406	337	296	622	529	410	833	686	535	1139	954	689	1418	1157	838					

VENT TABLES

Capacity of Masonry Chimney with Type B Double-Wall Vent Connectors
Serving a Single Category I Appliance

TABLE 5

Height H (ft)	Lateral L (ft)	Connector Diameter - D (Inches)																																		
		To be used with chimney areas within the size limits at bottom																																		
		3"		4"		5"		6"		7"		8"		9"		10"		12"																		
FAN		NAT		FAN		NAT		FAN		NAT		FAN		NAT		FAN		NAT		FAN		NAT														
Min		Max		Min		Max		Min		Max		Min		Max		Min		Max		Min		Max														
6	2	NR	NR	28	25*	NR	NR	86	82	NR	NR	130	117	NR	NR	180	165	NR	NR	247	231	NR	NR	320	298	NR	NR	401	376	NR	NR	581	561			
	5	NR	NR	NR	NR	NR	NR	103	96	NR	NR	162	148	NR	NR	221	204	NR	NR	298	277	NR	NR	388	365	NR	NR	491	466	NR	NR	724	712			
10	2	NR	NR	31	28*	NR	NR	61	57	NR	NR	103	96	NR	NR	221	204	NR	NR	298	277	NR	NR	388	365	NR	NR	491	466	NR	NR	724	712			
	5	NR	NR	NR	NR	NR	NR	NR	NR	NR	NR	148	139	NR	NR	204	181	NR	NR	277	263	NR	NR	365	347	NR	NR	466	444	NR	NR	712	668			
	10	NR	NR	NR	NR	NR	NR	NR	NR	NR	NR	139	87	NR	NR	181	NR	NR	NR	263	NR	NR	NR	347	NR	NR	NR	NR	NR	NR	NR	668	NR			
15	2	NR	NR	35*	33*	NR	NR	114	107	NR	NR	179	164	NR	NR	250	231	NR	NR	336	313	NR	NR	441	416	NR	NR	562	533	NR	NR	841	828			
	5	NR	NR	NR	NR	NR	NR	NR	NR	NR	NR	164	153	NR	NR	231	216	NR	NR	313	296	NR	NR	416	394	NR	NR	533	507	NR	NR	828	777			
	10	NR	NR	NR	NR	NR	NR	NR	NR	NR	NR	153	97	NR	NR	216	201	NR	NR	296	281	NR	NR	394	375	NR	NR	507	485	NR	NR	777	742			
	15	NR	NR	NR	NR	NR	NR	NR	NR	NR	NR	97	89*	NR	NR	201	NR	NR	NR	281	NR	NR	NR	485	NR	NR	NR	NR	NR	NR	NR	742	NR			
20	2	NR	NR	38*	36*	NR	NR	74	68*	NR	NR	201	184	NR	NR	274	254	NR	NR	375	350	NR	NR	491	463	NR	NR	627	597	NR	NR	953	933			
	5	NR	NR	NR	NR	NR	NR	NR	NR	NR	NR	184	107*	NR	NR	254	237	NR	NR	350	332	NR	NR	463	440	NR	NR	597	566	NR	NR	879	840			
	10	NR	NR	NR	NR	NR	NR	NR	NR	NR	NR	107*	97*	NR	NR	237	220	NR	NR	332	314	NR	NR	440	418	NR	NR	566	541	NR	NR	840	807			
	15	NR	NR	NR	NR	NR	NR	NR	NR	NR	NR	97*	83*	NR	NR	220	206	NR	NR	314	296	NR	NR	418	397	NR	NR	541	513	NR	NR	807	777			
	20	NR	NR	NR	NR	NR	NR	NR	NR	NR	NR	83*	NR	NR	206	NR	NR	NR	296	NR	NR	NR	397	NR	NR	NR	NR	NR	NR	NR	777	NR				
30	2	NR	NR	41*	NR	NR	NR	82*	76*	NR	NR	216	198	NR	NR	303	281	NR	NR	421	393	NR	NR	558	526	NR	NR	717	683	NR	NR	1112	1094			
	5	NR	NR	NR	NR	NR	NR	NR	NR	NR	NR	198	184*	NR	NR	281	263	NR	NR	393	373	NR	NR	526	500	NR	NR	683	648	NR	NR	1094	1025			
	10	NR	NR	NR	NR	NR	NR	NR	NR	NR	NR	184*	171*	NR	NR	263	243*	NR	NR	373	353	NR	NR	500	476	NR	NR	648	621	NR	NR	981	940			
	15	NR	NR	NR	NR	NR	NR	NR	NR	NR	NR	171*	159*	NR	NR	243*	227*	NR	NR	353	332	NR	NR	476	450	NR	NR	621	592	NR	NR	940	877			
	20	NR	NR	NR	NR	NR	NR	NR	NR	NR	NR	159*	185*	NR	NR	227*	188*	NR	NR	332	288*	NR	NR	450	416	NR	NR	592	555	NR	NR	877	812			
	30	NR	NR	NR	NR	NR	NR	NR	NR	NR	NR	83*	NR	NR	188*	NR	NR	NR	288*	NR	NR	NR	416	NR	NR	NR	NR	NR	NR	NR	812	774	NR	NR	1243	1225
50	2	NR	NR	NR	NR	NR	NR	92*	NR	NR	NR	251*	230*	NR	NR	351*	323*	NR	NR	477	445	NR	NR	633	596	NR	NR	812	774	NR	NR	1243	1225			
	5	NR	NR	NR	NR	NR	NR	NR	NR	NR	NR	230*	215*	NR	NR	323*	304*	NR	NR	445	424*	NR	NR	596	567	NR	NR	774	733	NR	NR	1225	1147			
	10	NR	NR	NR	NR	NR	NR	NR	NR	NR	NR	215*	199*	NR	NR	304*	282*	NR	NR	424*	400*	NR	NR	567	539*	NR	NR	733	702	NR	NR	1099	1050			
	15	NR	NR	NR	NR	NR	NR	NR	NR	NR	NR	199*	185*	NR	NR	282*	264*	NR	NR	400*	376*	NR	NR	539*	511*	NR	NR	702	669*	NR	NR	1099	1050			
	20	NR	NR	NR	NR	NR	NR	NR	NR	NR	NR	185*	NR	NR	264*	NR	NR	NR	376*	NR	NR	NR	511*	468*	NR	NR	669*	623*	NR	NR	1050	984				
	30	NR	NR	NR	NR	NR	NR	NR	NR	NR	NR	NR	NR	NR	NR	NR	NR	NR	327*	NR	NR	NR	468*	NR	NR	NR	NR	NR	NR	NR	984	NR				
Minimum Internal Area of Chimney Square Inches		12		19		28		38		50		63		78		95		132		132		132		132		132		132		132		132		132		
Maximum Internal Area of Chimney Square Inches		49		88		137		198		269		352		445		550		792		792		792		792		792		792		792		792		792		

VENT TABLES

Capacity of Masonry Chimney with Single-Wall Vent Connectors
Serving a Single Category I Appliance

TABLE 6

Height H (ft)	Lateral L (ft)	Connector Diameter - D (Inches)																					
		To be used with chimney areas within the size limits at bottom																					
		3"		4"		5"		6"		7"		8"		9"		10"		12"					
Appliance Input Rating in Thousands of Btu Per Hour																							
		FAN		NAT		FAN		NAT		FAN		NAT		FAN		NAT		FAN		NAT			
		Min	Max	Min	Max	Min	Max	Min	Max	Min	Max	Min	Max	Min	Max	Min	Max	Min	Max	Min	Max		
6	2	NR	NR	28	NR	NR	NR	86	NR	NR	130	NR	NR	247	NR	NR	319	NR	NR	400	NR	NR	580
	5	NR	NR	25*	NR	NR	NR	81	NR	NR	116	NR	NR	230	NR	NR	297	NR	NR	375	NR	NR	560
10	2	NR	NR	31	NR	NR	NR	102	NR	NR	161	NR	NR	297	NR	NR	387	NR	NR	490	NR	NR	722
	5	NR	NR	28*	NR	NR	NR	95	NR	NR	147	NR	NR	276	NR	NR	364	NR	NR	465	NR	NR	710
	10	NR	NR	24*	NR	NR	NR	86	NR	NR	137	NR	NR	261	NR	NR	345	NR	NR	441	NR	NR	665
15	2	NR	NR	35*	NR	NR	NR	113	NR	NR	178	NR	NR	335	NR	NR	440	NR	NR	560	NR	NR	840
	5	NR	NR	32*	NR	NR	NR	106	NR	NR	163	NR	NR	312	NR	NR	414	NR	NR	531	NR	NR	825
	10	NR	NR	27*	NR	NR	NR	96	NR	NR	151	NR	NR	294	NR	NR	392	NR	NR	504	NR	NR	774
	15	NR	NR	NR	NR	NR	NR	87*	NR	NR	138	NR	NR	278	NR	NR	372	NR	NR	481	NR	NR	738
20	2	NR	NR	38*	NR	NR	NR	123	NR	NR	200	NR	NR	374	NR	NR	490	NR	NR	625	NR	NR	950
	5	NR	NR	35*	NR	NR	NR	115	NR	NR	183	NR	NR	348	NR	NR	461	NR	NR	594	NR	NR	930
	10	NR	NR	NR	NR	NR	NR	105*	NR	NR	170	NR	NR	330	NR	NR	437	NR	NR	562	NR	NR	875
	15	NR	NR	NR	NR	NR	NR	95*	NR	NR	156	NR	NR	311	NR	NR	414	NR	NR	536	NR	NR	835
	20	NR	NR	NR	NR	NR	NR	80*	NR	NR	144*	NR	NR	292	NR	NR	392	NR	NR	510	NR	NR	800
30	2	NR	NR	41*	NR	NR	NR	136	NR	NR	215	NR	NR	420	NR	NR	556	NR	NR	715	NR	NR	1110
	5	NR	NR	NR	NR	NR	NR	127*	NR	NR	196	NR	NR	391	NR	NR	524	NR	NR	680	NR	NR	1090
	10	NR	NR	NR	NR	NR	NR	113*	NR	NR	182*	NR	NR	370	NR	NR	496	NR	NR	644	NR	NR	1020
	15	NR	NR	NR	NR	NR	NR	105*	NR	NR	168*	NR	NR	349	NR	NR	471	NR	NR	615	NR	NR	975
	20	NR	NR	NR	NR	NR	NR	88*	NR	NR	155*	NR	NR	327	NR	NR	445	NR	NR	585	NR	NR	932
	30	NR	NR	NR	NR	NR	NR	NR	NR	NR	NR	NR	NR	281*	NR	NR	408	NR	NR	544	NR	NR	865
50	2	NR	NR	NR	NR	NR	NR	160*	NR	NR	250*	NR	NR	475	NR	NR	631	NR	NR	810	NR	NR	1240
	5	NR	NR	NR	NR	NR	NR	149*	NR	NR	228*	NR	NR	442	NR	NR	593	NR	NR	770	NR	NR	1220
	10	NR	NR	NR	NR	NR	NR	136*	NR	NR	212*	NR	NR	420*	NR	NR	562	NR	NR	728	NR	NR	1140
	15	NR	NR	NR	NR	NR	NR	124*	NR	NR	195*	NR	NR	395*	NR	NR	533*	NR	NR	695	NR	NR	1090
	20	NR	NR	NR	NR	NR	NR	NR	NR	NR	180*	NR	NR	370*	NR	NR	504*	NR	NR	660*	NR	NR	1040
	30	NR	NR	NR	NR	NR	NR	NR	NR	NR	NR	NR	NR	318*	NR	NR	458*	NR	NR	610*	NR	NR	970
Minimum Internal Area of Chimney Square Inches		12		19		28		38		50		63		78		95		132					
Maximum Internal Area of Chimney Square Inches		49		88		137		198		269		352		445		550		792					

* SEE NOTE 27

VENT TABLES

Capacity of Masonry Chimney with Type B Double-Wall Connectors
Serving two or more Category I Appliances

TABLE 7

Vent Connector Capacity

Vent Height H (ft)		Connector Rise R (ft)		Vent Connector Diameter - D (Inches)																							
				3"		4"		5"		6"		7"		8"		9"		10"									
				Appliance Input Rating Limits in Thousands of Btu Per Hour																							
		FAN		NAT		FAN		NAT		FAN		NAT		FAN		NAT		FAN		NAT		FAN		NAT			
		Min	Max	Max	Min	Max	Max	Min	Max	Max	Min	Max	Max	Min	Max	Max	Min	Max	Max	Min	Max	Max	Min	Max	Max		
6	1	24	NR	21	39	62	40	52	106	67	65	194	101	87	274	141	104	370	201	124	479	253	145	599	319		
	2	26	43	28	41	79	52	53	133	85	67	230	124	89	324	173	107	436	232	127	562	330	148	694	378		
	3	27	49	34	42	92	61	55	155	97	69	262	143	91	369	203	109	491	270	129	633	349	151	795	439		
15	1	24	48	23	38	93	44	54	154	74	72	277	114	100	384	174	125	511	229	153	658	297	184	824	375		
	2	25	55	31	39	105	55	56	174	89	74	299	134	103	419	192	128	558	260	156	718	339	187	900	432		
	3	26	59	35	41	115	64	57	189	102	76	319	153	105	448	215	131	597	292	159	760	382	190	960	486		
30	1	24	54	25	37	111	48	52	192	82	69	357	127	96	504	187	119	680	255	145	883	337	175	1115	432		
	2	25	60	32	38	122	58	54	208	95	72	376	145	99	531	209	122	715	287	149	928	378	179	1171	484		
	3	26	64	36	40	131	66	56	221	107	74	392	163	101	554	233	125	746	317	152	968	418	182	1220	535		
50	1	23	52	26	36	116	49	51	209	82	67	405	133	92	582	198	115	798	271	140	1049	362	168	1334	462		
	2	24	59	31	37	127	58	53	225	96	70	421	152	95	604	222	118	827	304	143	1085	400	172	1379	510		
	3	26	64	37	39	135	66	55	237	108	72	435	170	98	624	247	121	854	334	147	1118	439	176	1421	558		

Common Vent Capacity

Vent Height H (ft)		Minimum Internal Area of Chimney, Square Inches																											
		12		19		28		38		50		63		78		113													
		Combined Appliance Input Rating in Thousands of Btu Per Hour																											
		FAN	FAN	NAT	FAN	FAN	NAT	FAN	FAN	NAT	FAN	FAN	NAT	FAN	FAN	NAT	FAN	FAN	NAT	FAN	FAN	NAT	FAN	FAN	NAT	FAN	FAN	NAT	
		+FAN	+FAN	+NAT	+FAN	+FAN	+NAT	+FAN	+FAN	+NAT	+FAN	+FAN	+NAT	+FAN	+FAN	+NAT	+FAN	+FAN	+NAT	+FAN	+FAN	+NAT	+FAN	+FAN	+NAT	+FAN	+FAN	+NAT	
6	NR	74	25	NR	119	46	NR	178	71	NR	257	103	NR	351	143	NR	458	188	NR	582	246	NR	853	NR					
	NR	80	28	NR	130	53	NR	193	82	NR	279	119	NR	384	163	NR	501	218	NR	636	278	NR	937	408					
10	NR	84	31	NR	138	56	NR	207	90	NR	299	131	NR	409	177	NR	538	236	NR	686	302	NR	1010	454					
	NR	90	36	NR	152	67	NR	233	106	NR	334	152	NR	467	212	NR	611	283	NR	781	365	NR	1156	546					
15	NR	92	41	NR	159	75	NR	250	122	NR	368	172	NR	508	243	NR	668	325	NR	858	419	NR	1286	648					
	NR	NR	NR	NR	NR	NR	NR	270	137	NR	404	198	NR	564	278	NR	747	381	NR	969	496	NR	1473	749					
30	NR	NR	NR	NR	NR	NR	NR	NR	NR	NR	NR	NR	NR	NR	NR	NR	NR	NR	NR	NR	NR	NR	NR	NR	NR				
	NR	NR	NR	NR	NR	NR	NR	NR	NR	NR	NR	NR	NR	NR	NR	NR	NR	NR	NR	NR	NR	NR	NR	NR	NR	NR			
50	NR	NR	NR	NR	NR	NR	NR	NR	NR	NR	NR	NR	NR	NR	NR	NR	NR	NR	NR	NR	NR	NR	NR	NR	NR				
	NR	NR	NR	NR	NR	NR	NR	NR	NR	NR	NR	NR	NR	NR	NR	NR	NR	NR	NR	NR	NR	NR	NR	NR	NR				

VENT TABLES

Capacity of Masonry Chimney with Single-Wall Connectors
Serving two or more Category I Appliances

TABLE 8

Vent Connector Capacity

Vent Height H (ft)	Connector Rise R (ft)	Vent Connector Diameter - D (Inches)																																	
		3"			4"			5"			6"			7"			8"			9"			10"												
		Appliance Input Rating Limits in Thousands of Btu Per Hour																																	
		FAN			NAT			FAN			NAT			FAN			NAT			FAN			NAT			FAN			NAT			FAN			NAT
Min	Max	Max	Min	Max	Max	Min	Max	Max	Min	Max	Max	Min	Max	Max	Min	Max	Max	Min	Max	Max	Min	Max	Max	Min	Max	Max	Min	Max	Max	Min	Max	Max			
6	1	NR	NR	21	NR	NR	39	NR	NR	66	179	191	100	231	271	140	292	366	200	362	474	252	499	594	283										
	2	NR	NR	28	NR	NR	52	NR	NR	84	186	227	123	239	321	172	301	432	231	373	557	299	509	696	331										
	3	NR	NR	34	NR	NR	61	134	153	97	193	258	142	247	365	202	309	491	269	381	634	344	519	793	375										
15	1	NR	NR	23	NR	NR	43	129	151	73	199	271	112	268	376	171	349	502	225	445	646	291	623	808	360										
	2	NR	NR	30	92	103	54	135	170	88	207	295	132	277	411	189	359	548	256	456	706	334	634	884	402										
	3	NR	NR	34	96	112	63	141	185	101	215	315	151	286	439	213	368	586	289	466	755	378	646	945	437										
30	1	NR	NR	24	86	108	47	126	187	80	193	347	124	259	492	183	338	665	250	430	864	330	600	1089	455										
	2	NR	NR	31	91	119	57	132	203	93	201	366	142	269	518	205	348	699	282	442	908	372	613	1145	490										
	3	NR	NR	35	95	127	65	138	216	105	209	381	160	277	540	229	358	729	312	452	946	412	626	1193	521										
50	1	NR	NR	25	85	113	48	124	204	80	188	392	130	252	567	194	328	778	265	417	1022	355	582	1302	537										
	2	NR	NR	31	89	123	57	130	218	94	196	408	149	262	588	218	339	806	298	429	1058	393	596	1346	567										
	3	NR	NR	35	94	131	65	136	231	106	205	422	167	271	607	243	349	831	328	440	1090	431	610	1386	595										

Common Vent Capacity

Vent Height H (ft)	Minimum Internal Area of Chimney, Square Inches																							
	12			19			28			38			50			63			78			113		
	Combined Appliance Input Rating in Thousands of Btu Per Hour																							
	FAN	FAN	NAT	FAN	FAN	NAT	FAN	FAN	NAT	FAN	FAN	NAT	FAN	FAN	NAT	FAN	FAN	NAT	FAN	FAN	NAT	FAN	FAN	NAT
	+FAN	+FAN	+NAT	+FAN	+FAN	+NAT	+FAN	+FAN	+NAT	+FAN	+FAN	+NAT	+FAN	+FAN	+NAT	+FAN	+FAN	+NAT	+FAN	+FAN	+NAT	+FAN	+FAN	+NAT
6	NR	73	25	NR	118	45	NR	176	71	NR	255	102	NR	348	142	NR	455	187	NR	579	245	NR	846	NR
8	NR	79	28	NR	128	52	NR	190	81	NR	276	118	NR	380	162	NR	497	217	NR	633	277	NR	928	405
10	NR	83	31	NR	136	56	NR	205	89	NR	295	129	NR	405	175	NR	532	234	NR	680	300	NR	1000	450
15	NR	88	36	NR	149	66	NR	230	105	NR	335	150	NR	460	210	NR	602	280	NR	772	360	NR	1139	540
20	NR	90	40	NR	157	74	NR	247	120	NR	362	170	NR	503	240	NR	661	321	NR	849	415	NR	1264	640
30	NR	NR	NR	NR	NR	NR	NR	266	135	NR	398	195	NR	558	275	NR	739	377	NR	957	490	NR	1447	740
50	NR	NR	NR	NR	NR	NR	NR	NR	NR	NR	NR	NR	NR	612	325	NR	821	456	NR	1076	600	NR	1672	910

TABLE 9

**MASONRY CHIMNEY LINER DIMENSIONS
WITH CIRCULAR EQUIVALENTS**

NOMINAL LINER SIZE INCHES	INSIDE DIMENSIONS IN LINER INCHES	INSIDE DIA. OR EQUIVALENT DIA. INCHES	EQUIVALENT AREA SQ. INCHES
4 x 8	2 1/2 x 6 1/2	4	12.2
		5	19.6
		6	28.3
		7	38.3
8 x 8	6 3/4 x 6 3/4	7.4	42.7
		8	50.3
8 x 12	6 1/2 x 10 1/2	9	63.6
		10	78.5
12 x 12	9 3/4 x 9 3/4	10.4	83.3
		11	95
12 x 16	9 1/2 x 13 1/2	11.8	107.5
		12	113
		14	153.9
16 x 16	13 1/4 x 13 1/4	14.5	162.9
		15	176.7
16 x 20	13 x 17	16.2	206.1
		18	254.4
20 x 20	16 3/4 x 16 3/4	18.2	260.2
		20	314.1
20 x 24	16 1/2 x 20 1/2	20.1	314.2
		22	380.1
24 x 24	20 1/4 x 20 1/4	22.1	380.1
		24	452.3
24 x 28	20 1/2 x 24 1/4	24.1	456.2
28 x 28	24 1/4 x 24 1/4	26.4	543.3
		27	572.5
30 x 30	25 1/2 x 25 1/2	27.9	607
		30	706.8
30 x 36	25 1/2 x 31 1/2	30.9	749.9
		33	855.3
36 x 36	31 1/2 x 31 1/2	34.4	929.4
		36	1017.9

When liner sizes differ dimensionally from those shown in Table 9 equivalent diameters may be determined from published tables for square and rectangular ducts of equivalent carrying capacity or by other engineering methods.

EXAMPLES USING SINGLE APPLIANCE VENTING TABLES

Example 1: Single Draft-Hood-Equipped Appliance

Suppose that an installer has a 120,000 Btu/hr input appliance with a 5 inch diameter draft hood outlet that needs to be vented into a 10 foot high Type B vent system. What size vent should be used assuming (a) a 5-Ft lateral single-wall metal vent connector is used with two 90° elbows, (b) a 5-Ft lateral single-wall metal vent connector is used with three 90° elbows in the vent system?

Solution

Table 2 should be used to solve this problem because single-wall metal vent connectors are being used with a Type B vent: Refer to Figure 4 of Typical Applications.

- (a) Read down the first column in Table 2 until the row associated with a 10-Ft height and 5-Ft lateral is found. Read across this row until a vent capacity greater than 120,000 Btu/hr is located in the shaded columns labeled "NAT Max" for draft-hood-equipped appliances. In this case, a 5 inch diameter vent has a capacity of 122,000 Btu/hr and may be used for this application.
- (b) If three 90° elbows are used in the vent system, then the maximum vent capacity listed in the tables must be reduced by 10 percent (see Note 3). This implies that the 5 inch diameter vent has an adjusted capacity of only 110,000 Btu/hr. In this case, the vent system must be increased to 6 inches in diameter. See calculations below:

$$122,000 \times .90 = 110,000 \text{ for } 5" \text{ Vent}$$

From Table 2 - Select 6" Vent

$186,000 \times .90 = 167,000$; This is greater than the required 120,000, therefore use a 6" Vent and connector when three elbows are used.

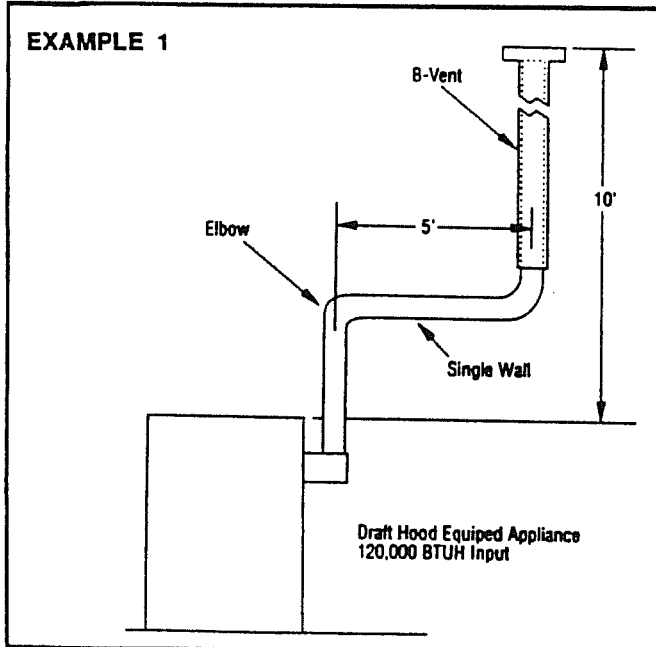

Example 2: Single Fan-Assisted Appliance

Suppose an installer has an 80,000 Btu/hr input fan-assisted appliance that must be installed using 10 feet of lateral connector attached to a 30-Ft high Type B vent. Two 90° elbows are needed for the installation. Can a single-wall metal vent connector be used for this application?

Solution

Table 2 refers to the use of single-wall metal vent connectors with Type B vent. In the first column find the row associated with a 30-Ft height and a 10-Ft lateral. Read across this row, looking at the "FAN Min" and "FAN Max" columns, to find that a 3 inch diameter single-wall metal connector vent is not recommended. Moving to the next larger size single wall connector (4") we find that a 4 inch diameter single-wall metal connector has a recommended minimum vent capacity of 91,000 Btu/hr and a recommended maximum vent capacity of 144,000 Btu/hr. The 80,000 Btu/hr fan-assisted appliance is outside this range, so we conclude that a single-wall metal vent connector cannot be used to vent this appliance using 10 feet of lateral for the connector.

However, we see that if the 80,000 Btu/hr input appliance could be moved to within 5 feet of the vertical vent, then a 4 inch single-wall metal connector could be used to vent the appliance. Table 2 shows the acceptable range of vent capacities for a 4 inch vent with 5 feet of lateral to be between 72,000 Btu/hr and 157,000 Btu/hr.

If the appliance cannot be moved closer to the vertical vent, then Type B vent could be used as the connector material. In this case, Table 1 shows that for a 30-Ft high vent with 10 feet of lateral, the acceptable range of vent capacities for a 4 inch diameter vent attached to a fan-assisted appliance are between 37,000 Btu/hr and 150,000 Btu/hr.

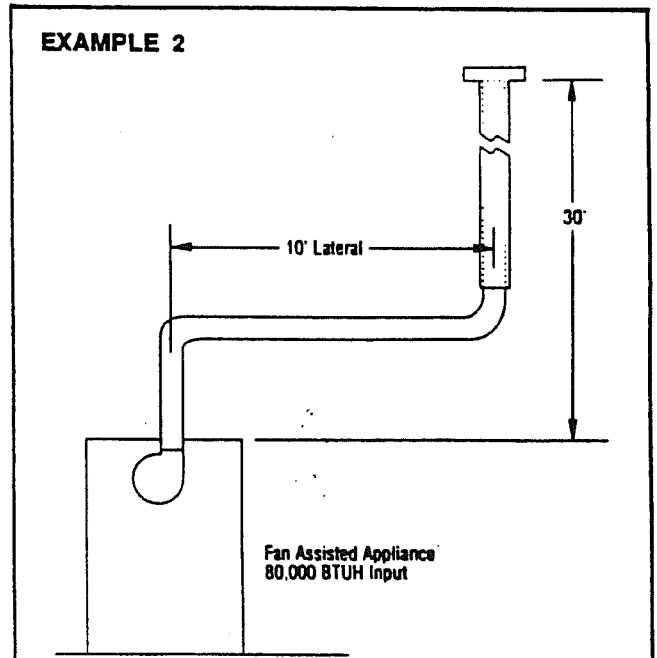

Example 3: Common Venting Two Draft-Hood Appliances

Suppose a 35,000 Btu/hr water heater is to be common vented with a 150,000 Btu/hr furnace using a common vent with a total height of 30 feet. The connector rise is 2 feet for the water heater and 3 feet for the furnace. Assume single-wall metal connectors will be used with Type B vent. What size connectors and combined vent should be used in this installation?

Solution - (Table 4 applies in this example)

Table 4 should be used to size single-wall metal vent connectors attached to Type B vertical vent. In the vent connector capacity Table 4, find the row associated with a 30-Ft vent height. For a 2-Ft rise on the vent connector for the water heater, read the shaded columns for draft-hood-equipped appliances to find that a 3 inch diameter vent connector has a capacity of 37,000 Btu/hr.

Therefore, a 3 inch single-wall metal vent connector may be used with the water heater. For a draft-hood-equipped furnace with a 3-Ft rise, read across the appropriate row to find that a 5 inch diameter vent connector has a maximum capacity of 120,000 Btu/hr (which is too small for the furnace) and a 6 inch diameter vent connector has a maximum vent capacity of 172,000 Btu/hr. Therefore, a 6 inch diameter vent connector should be used with the 150,000 Btu/hr furnace.

For the capacity of the combined vent, the lower portion of Table 4 should be used. The combined vent capacity required is 185,000 Btu/hr. Table 4 shows that the combined vent capacity of a 6 inch diameter vent with a 30-Ft vent height is 257,000 Btu/hr. This is more than adequate to handle the 35,000 Btu/hr input water heater and the 150,000 Btu/hr input furnace.

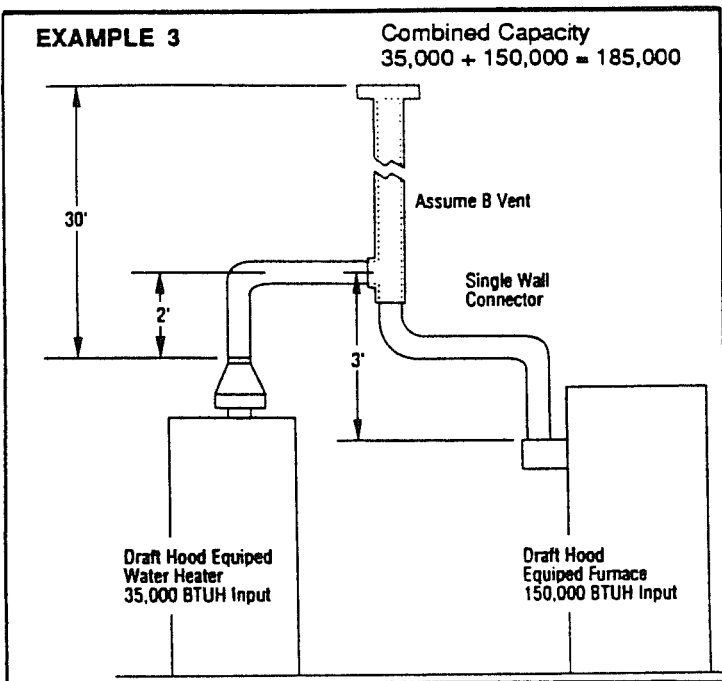

Example 4: Common Venting a Draft Hood Water Heater with a Fan-Assisted Furnace

In this case, a 35,000 Btu/hr input draft-hood-equipped water heater with a 2 foot connector rise is to be common vented with a 100,000 Btu/hr fan-assisted furnace with a 3-Ft connector rise. The common vent consists of a 30-Ft rise of Type B vent. What are the recommended vent diameters for each connector and the common vent?

Solution - (Table 4)

Water Heater Vent Connector Diameter. Let us assume the installer would like to use a single-wall metal vent connector. Using Table 4, Vent Connector Capacity, read down the Total Vent Height "H" column to 30 feet and read across the 2-Ft Connector Rise "R" row to the first Btu/hr rating in the "NAT Max" column that is equal to or greater than the water heater input rating. The table shows that a 3 inch vent connector has a maximum input rating of 37,000 Btu/hr. Since this is greater than the water heater input rating, a 3 inch vent connector is adequate. Furthermore, since the water heater is equipped with a draft hood, there are no minimum input rating restrictions.

Furnace Vent Connector Diameter. Again, let us assume the installer would like to use a single-wall metal vent connector. Using Table 4, Vent Connector Capacity, read down the Total Vent Height "H" column to 30 feet and across the 3-ft Connector Rise "R" row. Since the furnace has a fan-assisted combustion system, find the first "FAN Max" column with a Btu/hr rating greater than the furnace input rating. The 4 inch vent connector has a maximum input rating of 119,000 Btu/hr and a minimum input rating of 85,000 Btu/hr. The 100,000 Btu/hr furnace in this example falls within this range, so a 4 inch connector is adequate. If the furnace would have had an input rating of 80,000 Btu/hr, than a Type B vent connector (see Table 4) would have to be used in order to meet the minimum capacity limit.

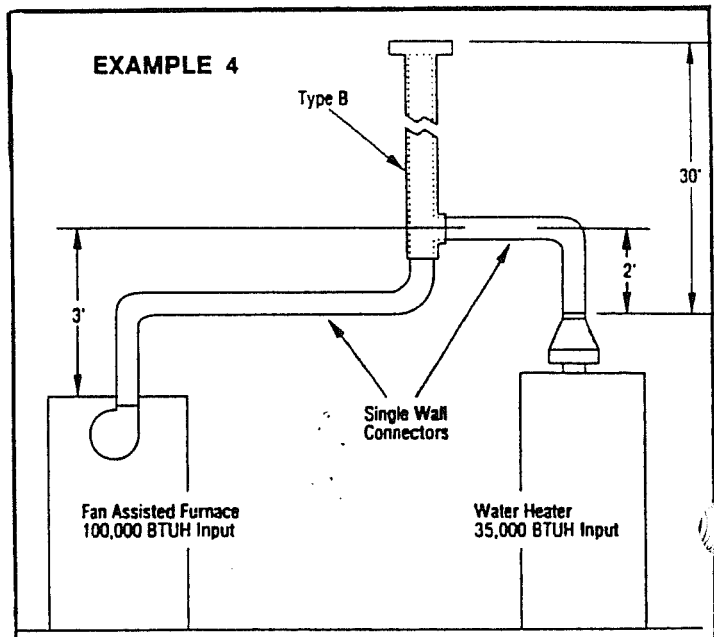

EXAMPLES USING COMMON VENTING TABLES

Example 4: (cont'd)

Common Vent Diameter. The total input to the common vent is 135,000 Btu/hr. Using Table 4, Common Vent Capacity, read down the Total Vent Height "H" column to 30 feet and across this row to find the smallest vent diameter in the "FAN+NAT" column that has a Btu/hr rating equal to or greater than 135,000 Btu/hr. The 4 inch common vent has a capacity of 132,000 Btu/hr and the 5 inch common vent has a capacity of 202,000 Btu/hr. Therefore, the 5 inch common vent should be used in this example.

Summary. In this example, the installer may use a 3 inch diameter, single-wall metal vent connector for the water heater and a 4 inch diameter, single-wall metal vent connector for the furnace. The common vent should be a 5 inch diameter Type B vent.

Example 5: Single Draft Hood Equipped Furnace Vented into A Masonry Chimney

A 135,000 Btu/hr draft hood equipped furnace is to be vented into a 15' high tile lined masonry chimney. The chimney is not exposed to the outside except above the roof line. The furnace has a 6" diameter draft hood outlet and requires a 10' lateral vent connector with 3 elbows. The chimney is constructed using a 8" x 8" liner. What size single wall vent connector is required?

Solution:

Table 6 should be used. Refer to the figure for Example 5.

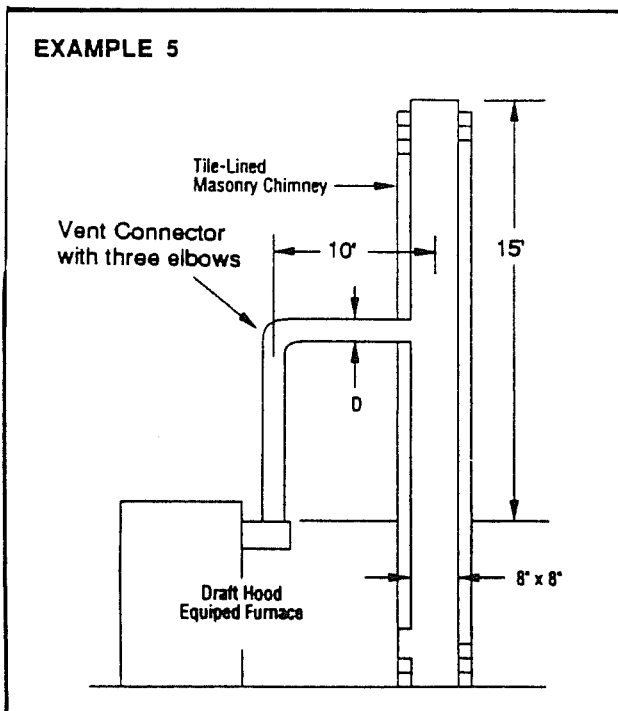

To determine the required vent connector diameter, read down the height column in Table 6 until 15' is found. Find the row for a 10' long lateral. The table shows that a 6" diameter connector will allow a maximum capacity of 151,000 Btu/hr for "Nat Max." (draft-hood equipped) furnace. Because 3 elbows are required, however, the maximum capacity must be reduced by 10% (See Note 3). Allowing for the additional elbow the corrected maximum capacity is 135,900 Btu/hr. A 6" diameter connector is large enough and should be used. The internal area of the chimney is 8" x 8" = 64 sq. in. and is within the acceptable range (38 sq. in. to 198 sq. in.) for a 6" vent connector as shown in Table 6.

Example 6: Common venting into a Masonry Chimney

In this case, a 35,000 Btu/hr input 4 inch diameter outlet draft hood-equipped water heater with 2 feet of connector rise and 4 feet of horizontal length is to be common vented with a 100,000 Btu/hr fan-assisted furnace with a 4 inch diameter flue collar, 3 feet of connector rise and 6 feet of horizontal length. The common vent is an 8 x 12 tile lined chimney that is 30 feet tall. What are the recommended vent diameters for each connector? Is this an acceptable installation?

Solution

Table 8 is used to size common venting installations involving single wall connectors into masonry chimneys.

Water Heater Vent Connector Diameter. Using Table 8, Vent Connector Capacity, read down the Total Vent Height "H" column to 30 feet and read across the 2 ft Connector Rise "R" row to the first Btu/hr rating in the "NAT MAX" column that is equal to or greater than the water heater input rating. The Table shows that a 3 inch vent connector has a maximum input of only 31,000 Btu/hr while a 4 inch vent connector has a maximum input of 57,000 Btu/hr. A 4 inch vent connector must therefore be used.

Furnace Vent Connector Diameter. Using Table 8 Vent Connector Capacity, read down the Total Vent Height "H" column to 30 feet and across the 3 ft Connector Rise "R" row. Since the furnace has a fan-assisted combustion system, find the first "FAN MAX" column with a Btu/hr rating greater than the furnace input rating. The 4 inch vent connector has a maximum input rating of 127,000 Btu/hr and a minimum input rating of 95,000 Btu/hr. The 100,000 Btu/hr furnace in this example falls within this range, so a 4 inch connector is adequate.

EXAMPLE 6: (cont'd)

Masonry Chimney. From Table 9, the Equivalent Area for a Nominal Liner size of 8 inches x 12 inches is 63.6 square inches. Using Table 8, Common Vent Capacity, read down the "Fan + Nat" column under the Minimum internal Area of Chimney value of 63 to the row for 30-ft height, to find a capacity value of 739,000 Btu/hr. The combined input rating of the furnace and water heater 135,000 Btu/hr, is less than the Table value, so this is an acceptable installation.

Note 19 requires the common vent area to be no greater than seven times the flow area of the smallest appliance outlet area. Both appliances in this installation use 4 inch diameter outlets. From Table 9, the Equivalent Area for an Inside Diameter of 4 inches is 12.2 square inches. Seven times 12.2 is 85.4, which is greater than 63.6, so this configuration is acceptable.

Note 1 specifies that the Table values are for vents or chimneys which are not exposed to the outdoors below the roofline. If the masonry chimney in this case were exposed below the roofline, then the appliance manufacturer, local gas utility, and/or authority having jurisdiction must be consulted.

Example 7: Interpolating Between Table Values

An installer has an 80,000 Btu/hr input appliance with a 4 inch diameter draft hood outlet that needs to be vented into a 12-ft high Type B vent. The vent connector has a 5 ft lateral length and is also Type B. Can this appliance be vented using a 4 inch diameter vent?

Solution

Table 1 is used in the case of an all Type B vent system. However, since there is no entry in Table 1 for height of 12 feet, interpolation must be used. Read down the 4 inch diameter "NAT Max" column to the row associated with 10 ft. height and 5 ft. lateral to find the capacity value of 77,000 Btu/hr. Go down further to the 15 ft. height, 5 ft. lateral row to find the capacity value of 87,000 Btu/hr. The difference between the 15 ft. height capacity value and the 10 ft. height capacity value is 10,000 Btu/hr. The capacity for a vent system with a 12 ft. height is equal to the capacity for a 10 ft. height plus $2/5$ of the difference between the 10 ft. and 15 ft. height values, or $77,000 + 2/5 \times 10,000 = 81,000$ Btu/hr. Therefore, a 4 inch diameter vent may be used in the installation.

Multi-story Gas Vent Design Procedure
for Each Segment of System

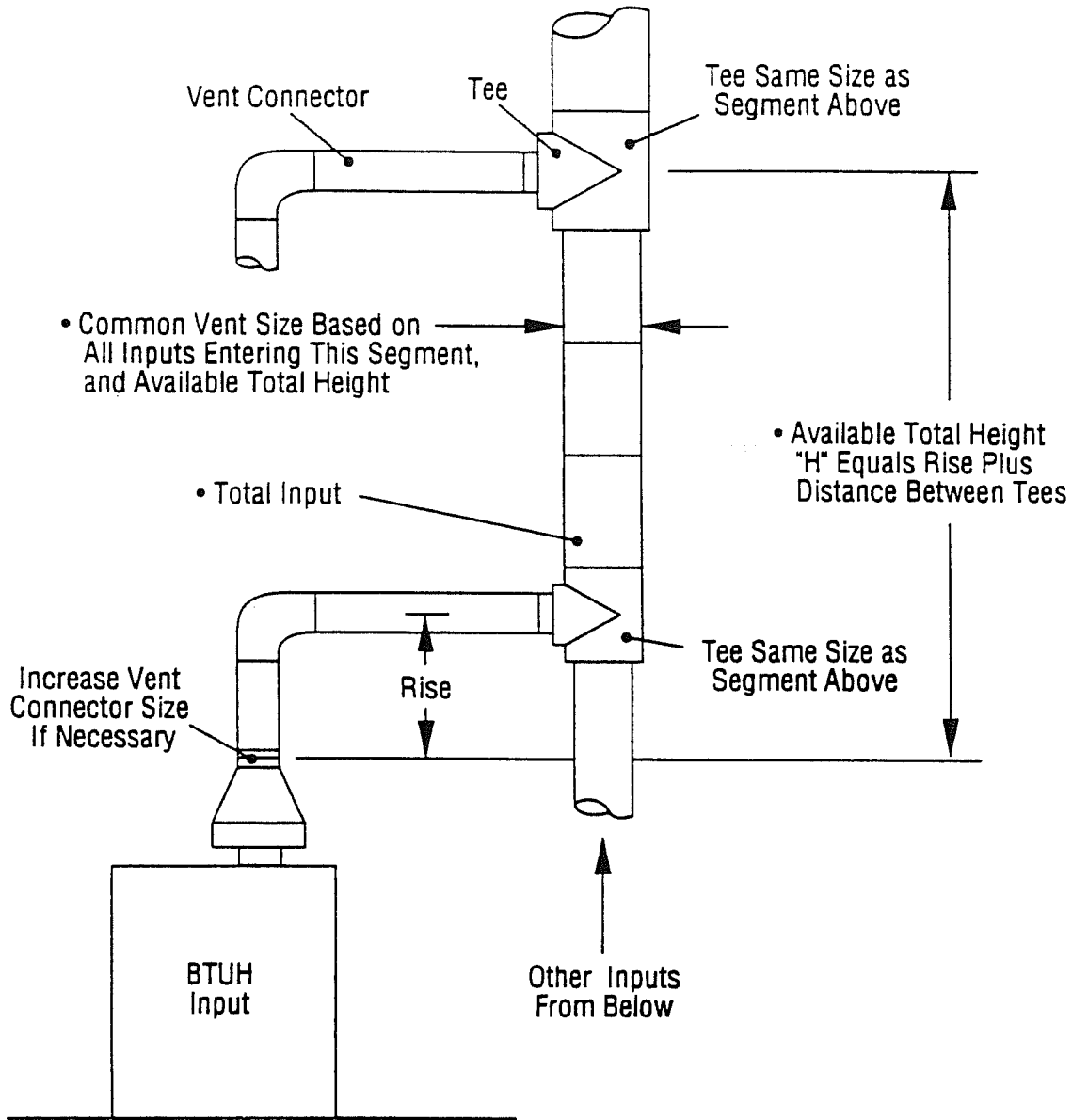

- Vent Connector Size Depends On:**
- Input
 - Rise
 - Available Total Height "H"
 - Table 3 Connectors

- Common Vent Size Depends On:**
- Combined Inputs
 - Available Total Height "H"
 - Table 3 Common Vent
 - Vertical Common Vent With No Offsets

Figure 13

Multi-story Vent Systems

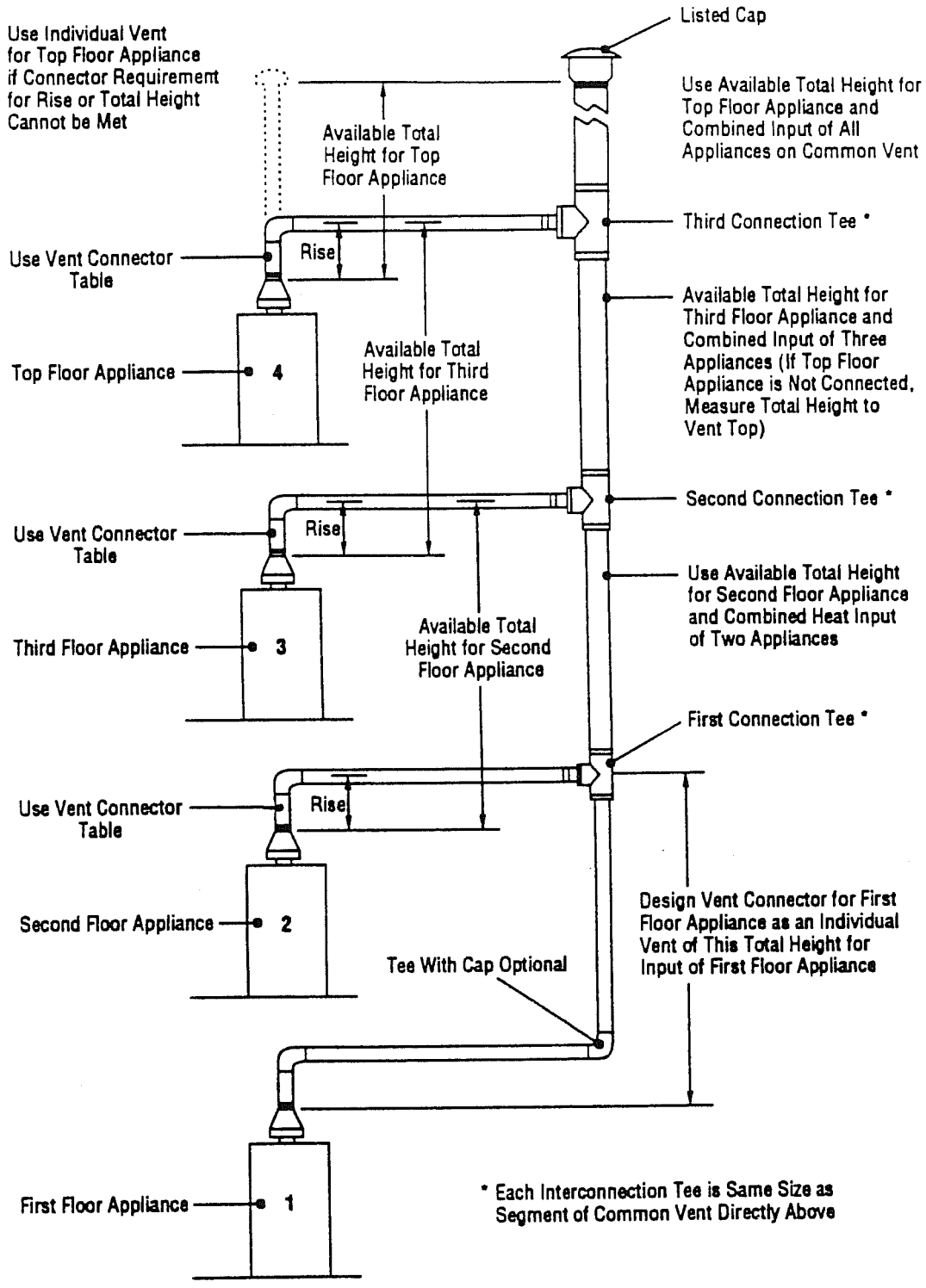

Principles of Design of Multi-story Vents Using Vent Connector and Common Vent Design Tables

Figure 14