



Diamondback
Flexible Gas Piping

Slate-It!
Products of
Metal-Fab Inc.
Wichita, KS 67201

Diamondback
Flexible Gas Piping

Slate-It!
Products of
Metal-Fab Inc.
Wichita, KS 67201

METAL-FAB INC.



DIAMONDBACK® (CSST)
FLEXIBLE STAINLESS STEEL GAS PIPING

FOR USE WITH GAS-FIRED APPLIANCES.

DIAMONDBACK® FLEXIBLE TUBING (CSST)



CAT. NO.	TUBING SIZE		EHD*	O.D.	I.D.	SPOOL SIZE
	IN.	MM				
375DFT	3/8"	(10)	15	.585	.464	250'
500DFT	1/2"	(15)	19	.748	.610	250'
500DFTS	1/2"	(15)	19	.748	.610	100'
750DFT	3/4"	(20)	25	1.023	.844	250'
750DFTS	3/4"	(20)	25	1.023	.844	100'
1000DFT	1"	(25)	31	1.307	1.092	150'
1250DFT	1 1/4"	(32)	37	1.597	1.322	125'

*EHD (Effective Hydraulic Diameter) is a relative measure of flow capacity

Use: Conveyance of natural gas or propane gas (LP).

DIAMONDBACK® STRAIGHT MECHANICAL FITTINGS

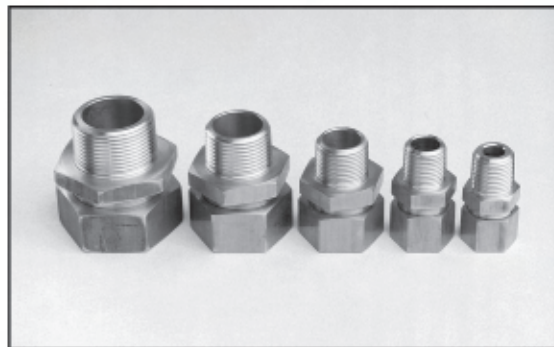

CAT. NO.	TUBING SIZE		NPT THREAD SIZE	
	IN.	MM	IN.	MM
375DMF	3/8"	(10)	1/2"	(15)
500DMF	1/2"	(15)	1/2"	(15)
750DMF	3/4"	(20)	3/4"	(20)
1000DMF	1"	(25)	1"	(25)
1250DMF	1 1/4"	(32)	1 1/4"	(32)

Use: Connects CSST flexible gas piping to a manifold, immovable gas appliance, or gas outlet.

DIAMONDBACK® STRAIGHT MECHANICAL COUPLINGS

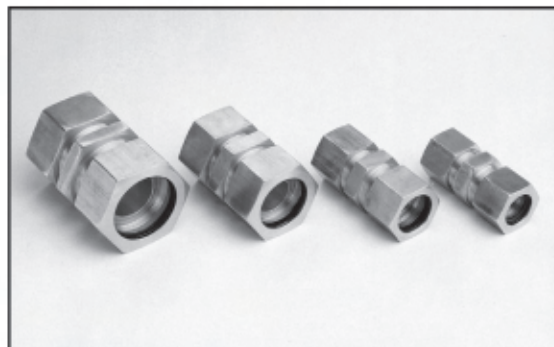

CAT. NO.	FITS TUBING SIZE	
	IN.	MM
375DC	3/8"	(10)
500DC	1/2"	(15)
750DC	3/4"	(20)
1000DC	1"	(25)

Use: Mechanical coupling to connect tubes of the same size.

DIAMONDBACK® BRASS TEE FITTINGS

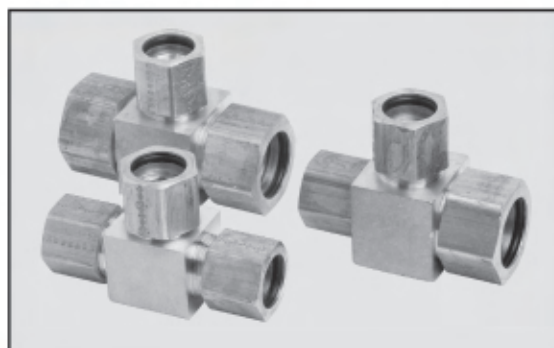

CAT. NO.	DESCRIPTION
DT555	1/2" x 1/2" x 1/2" Brass Tee Fitting
DT7555	3/4" x 1/2" x 1/2" Brass Tee Fitting
DT75575	3/4" x 1/2" x 3/4" Brass Tee Fitting
DT151	1" x 1/2" x 1" Brass Tee Fitting
DT17575	1" x 3/4" x 3/4" Brass Tee Fitting
DT1751	1" x 3/4" x 1" Brass Tee Fitting

Use: To connect tubing of different sizes.

TERMINATION FLANGE FITTINGS



Indoor termination fitting with iron flange.



Outdoor termination fitting with brass flange.

INDOOR CAT. NO.	OUTDOOR CAT. NO.	FITS TUBING SIZE		NPT THREAD SIZE	
		IN.	MM	IN.	MM
375DFF	375DBFF	3/8"	(10)	1/2"	(15)
500DFF	500DBFF	1/2"	(15)	1/2"	(15)
750DFF	750DBFF	3/4"	(20)	3/4"	(20)
1000DFF	1000DBFF	1"	(25)	1"	(25)

Use: Termination of gas line.

TERMINATION MOUNTING BRACKET

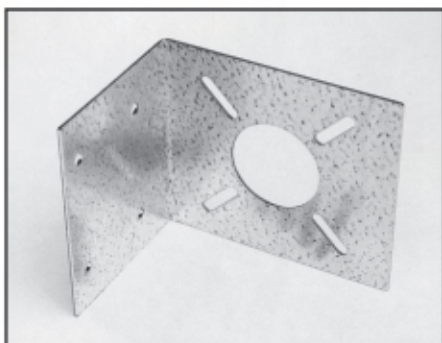

CAT. NO.	DESCRIPTION
DTMB	One part fits 3/8" (10) - 1" (25)

Use: To support termination flange fitting in through-the-wall installations.



MULTI-PORT COATED STEEL MANIFOLDS

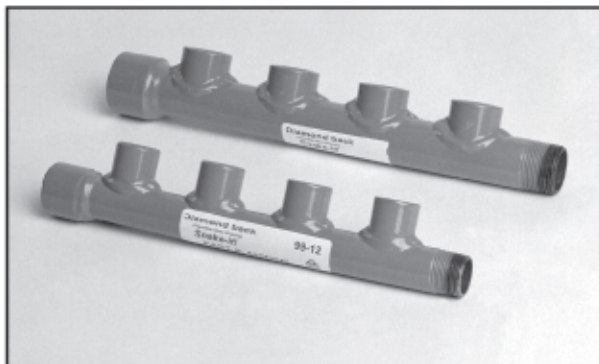

CAT. NO.	INLET/OUTLET		FEMALE OUTLET PORTS
	IN.	MM	
500DSM	3/4"	(20) FEMALE IN	ALL FOUR @ 1/2" (15)
	1/2"	(15) MALE OUT	
750DSM	1"	(25) FEMALE IN	ALL FOUR @ 3/4" (20)
	3/4"	(20) MALE OUT	

Use: Multi-port distribution enabling individual runs to multiple outlets.

MANIFOLD BRACKET

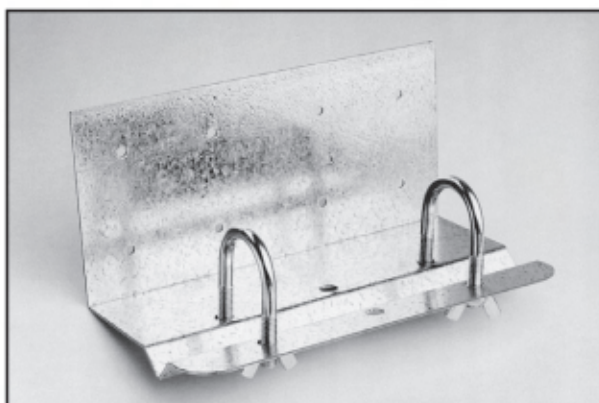

CAT. NO.	DESCRIPTION
DMB	Fits multiport steel manifolds or field fabricated black iron manifold

Use: Securely anchors manifold to wall.

STRIKER PLATES

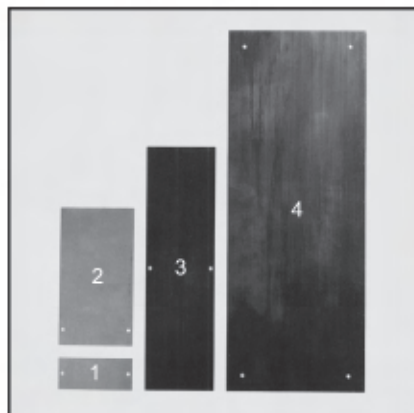

PICT. NO.	CAT. NO.	DESCRIPTION
1	DSPQ	3" X 2" STRIKER PLATE, QUARTER
2	DSPH	3" x 7" STRIKER PLATE, HALF
3	DSPF	3" x 12" STRIKER PLATE, FULL
4	DSPX	6 1/2" x 17" STRIKER PLATE, XL

Use: Protection of tubing from puncture.

FLOPPY CONDUIT



CAT. NO.	FITS		COIL DESCRIPTION
	IN.	MM	
375DFC	3/8"	(10)	3/4" x 50' COIL
500DFC	1/2"	(15)	1" x 50' COIL
750DFC	3/4"	(20)	1 1/4" x 50' COIL
1000DFC	1"	(25)	1 1/2" x 25' COIL
1250DFC	1 1/4"	(32)	2" x 25' COIL

CAT. NO.	FITS		COIL DESCRIPTION
	IN.	MM	
375DFC-1	3/8"	(10)	3/4" x 1' LENGTH
500DFC-1	1/2"	(15)	1" x 1' LENGTH
750DFC-1	3/4"	(20)	1 1/4" x 1' LENGTH
1000DFC-1	1"	(25)	1 1/2" x 1' LENGTH
1250DFC-1	1 1/4"	(32)	2" x 1' LENGTH

Use: Protection of tubing from puncture.

PRESSURE REGULATORS



2PSI

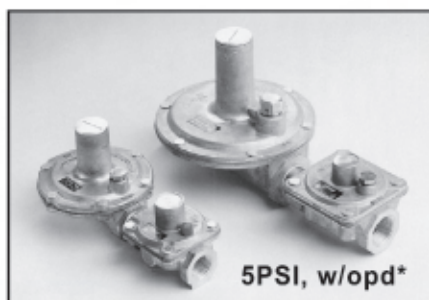

5PSI, w/opd*

CAT. NO.	INLET THREAD		DESCRIPTION
	IN.	MM	
500DR3N	1/2"	(15)	2PSI NATURAL GAS REGULATOR
500DR3P	1/2"	(15)	2PSI PROPANE GAS REGULATOR
750DR5A	3/4"	(20)	2PSI NATURAL GAS REGULATOR
500DR3XN	1/2"	(15)	5PSI NATURAL GAS REGULATOR W/OPD*
750DR5XA	3/4"	(20)	5PSI NATURAL GAS REGULATOR W/OPD*

Use: Installed in elevated pressure systems to reduce pressure to standard appliance pressure.

Note: Regulator Manufacturer specifies 7" spring setting for natural gas and 11" setting for propane.

*Overpressure protection device.

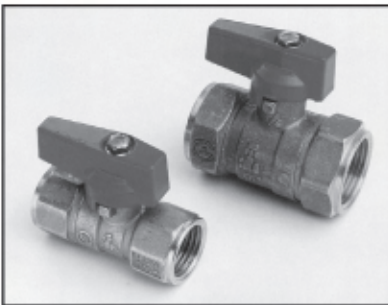
5PSI SHUTOFF BALL VALVES

CAT. NO.	SIZE		PRESSURE RATING
	IN.	MM	
500DBV	1/2"	(15)	5PSI
750DBV	3/4"	(20)	5PSI

Use: Installed on the elevated pressure side of the pressure regulator.

Note: Standard approved valves may be used on the low pressure side of the installation.

QUICK-CONNECT KIT

CAT. NO.	SIZE		PRESSURE RATING
	IN.	MM	
500DQCK	1/2"	(15)	5PSI

Use: Safe & easy connect & disconnect to moveable appliances.

TUBE CUTTER

CAT. NO.	DESCRIPTION
DTC	Fits 3/8" (10) - 3/4" (20)

Use: Cut and de-burr stainless steel tubing.

REPLACEMENT FITTINGS SPLIT RINGS

CAT. NO.	FITS TUBING SIZE	
	IN.	MM
375DSR	3/8"	(10)
500DSR	1/2"	(15)
750DSR	3/4"	(20)
1000DSR	1"	(25)

Use: Spare rings for fittings and couplings.

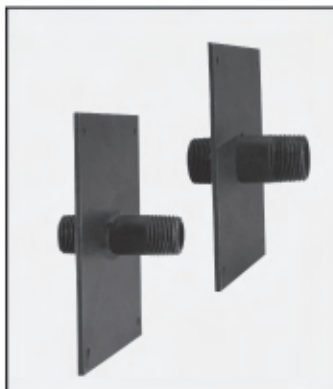
TERMINATION FITTINGS STRAIGHT STUB-OUT AND 90° STUB-OUT

CAT. NO.	FITS TUBING SIZE		NPT THREAD SIZE	
	IN.	MM	IN.	MM
500DTF	1/2"	(15)	1/2"	(15)
500D90TF	1/2"	(15)	1/2"	(15)
750DTF	3/4"	(20)	3/4"	(20)

Use: Termination of gas line.



SALES / TRAINING MATERIALS

Helpful tools to help you sell and install Diamondback® Flexible Gas Piping



PRODUCT MANUAL

ORDER FORM NO. L1644



SALES BROCHURE

ORDER FORM NO. L1626



FULL SAMPLE KIT

ORDER FORM NO. DFT SAMPLE

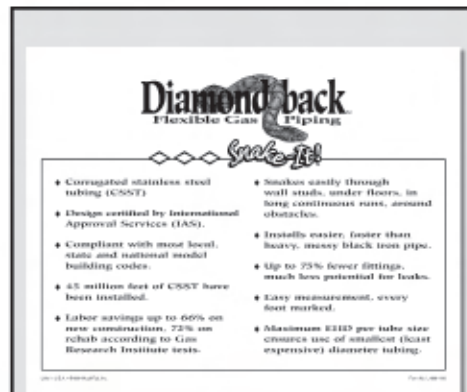

AD SLICK

ORDER FORM NO. L1606

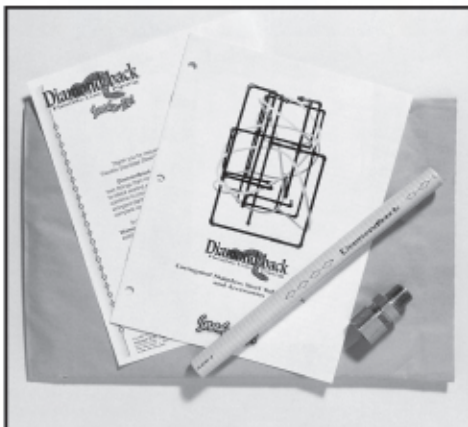

SMALL SAMPLE KIT

ORDER FORM NO. DBS12

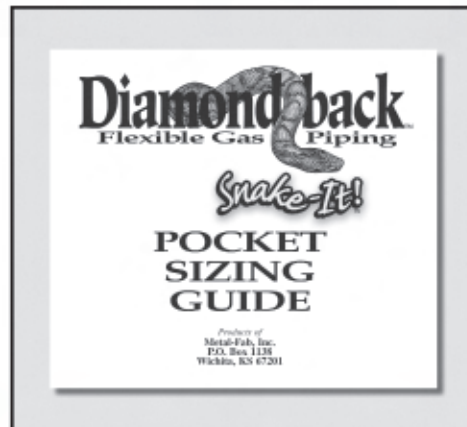

POCKET SIZING GUIDE

ORDER FORM NO. L1647

Diamond back
Flexible Gas Piping
Snake-It!

DESIGN GUIDE
AND
INSTALLATION
INSTRUCTION
MANUAL

888-80-Snake

Product of
Metal-Fab, Inc.
P.O. Box 2007 • Piquette, MI 49751
Tel: 519-221-1111 • Fax: 519-221-1112

DESIGN & INSTALLATION GUIDE
ORDER FORM NO. L1627

English & French Version Available

Diamond back
Flexible Gas Piping

Corrugated Stainless Steel Tubing (CSST)
and Accessories

Snake-It!

Product of
Metal-Fab, Inc.

HEADQUARTERED HERE!

WALL POSTER
ORDER FORM NO. L1651

Diamond back
Flexible Gas Piping
Snake-It!

CERTIFIED
INSTRUCTOR'S
MANUAL

NAME: _____ DATE: _____
COMPANY: _____ PHONE #: _____

Product of
Metal-Fab, Inc.
P.O. Box 2007 • Piquette, MI 49751
Tel: 519-221-1111 • Fax: 519-221-1112

INSTRUCTOR TRAINING MANUAL
ORDER FORM NO. L1643

Diamond back
Flexible Gas Piping
Snake-It!

Installer
Training Class

Sign up now for installation training
on this great new product!

Next Class

Date: _____ Time: _____
Location: _____

**TRAINING CLASS ANNOUNCEMENT
COUNTER CARD**
ORDER FORM NO. L1645

GENUINE
Metal-Fab
Quality

PRICE
LIST

Snake-It!

Suggested List Prices
Diamond back
Flexible Gas Piping

- Tubing
- Fittings
- Accessories
- Tools

PRICE SHEET
ORDER FORM NO. L1630

Diamond back
Flexible Gas Piping
Snake-It!

INSTALLER
TRAINING
MANUAL

NAME: _____ DATE: _____

Product of
Metal-Fab, Inc.
P.O. Box 2007 • Piquette, MI 49751
Tel: 519-221-1111 • Fax: 519-221-1112

INSTALLER TRAINING MANUAL
ORDER FORM NO. L1634

TRAINING DVD

METAL-FAB INC.
DIAMONDBACK
TRAINING DVD

Diamond back
Flexible Gas Piping

"TRAIN THE TRAINER" DVD
ORDER FORM NO. L1607

Diamondback™

Flexible Gas Piping

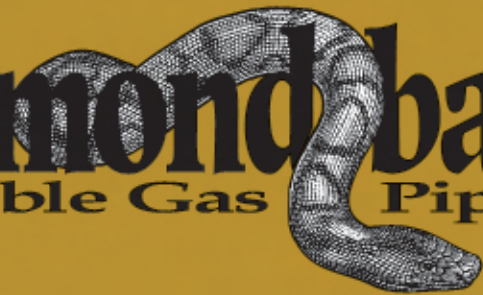

800-835-2830



P.O. BOX 1138 • WICHITA, KANSAS 67201 • (316) 943-2351 • FAX (316) 771-4154 • e-mail: info@metal-fabinc.com • www.metal-fabinc.com

Litho in U.S.A. ©2010 Metal-Fab Inc.

Form No. L1626-3/10